

WEO®

GUIDE TECHNIQUE



Fiberdeck®



WEO® est un bardage en bois composite
co-extrudé à faux claire-voie

Son profil trapézoïdal permet aussi bien
une pose horizontale que verticale

WEO® se caractérise par un bois composite de dernière génération issu de la coextrusion. Les lames sont protégées par un film en polyéthylène qui enrobe toute leur surface et garantit ainsi toute reprise d'humidité. Il est de plus insensible aux taches et à la décoloration.



PROFILS & ACCESSOIRES



LAME BARDAGE WEO® 35
33x170mm x 2.9m | 33x170mm x 3.9m



Cedar
2.9M FD1544
3.9M FD1548



Teak
2.9M FD1541
3.9M FD1545



Ipe
2.9M FD1542
3.9M FD1546



Dark Grey
2.9M FD1543
3.9M FD1547



LAME BARDAGE WEO® 60
33x170mm x 2.9m | 33x170mm x 3.9m

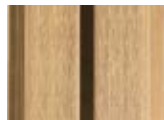

Cedar
2.9M FD1567
3.9M FD1571



Teak
2.9M FD1565
3.9M FD1569



Ipe
2.9M FD1566
3.9M FD1570



Dark Grey
2.9M FD1568
3.9M FD1572



VIS INOX SR2 BOITE DE 100 PCS + EMBOUT
4,2 x 38 mm | | 6 m²

FD1451 | ■ Cedar (RAL1011/Pantone 2312C) FD1448 | ■ Ipe (RAL8028/Pantone 4975C)
FD1447 | ■ Teak (RAL8024/ Pantone 469C) FD1450 | ■ Dark Grey (RAL7022/Pantone 425C)

**Disponible en bi-métal pour ossature acier*



VIS INOX BARDAGE WEO® 60 POUR POSE INVISIBLE
4.2x32mm | 500pcs + embout
FD1337



PROFIL F ALUMINIUM (2 PCS)
65 x 80 mm x 3,60 m

FD1428 | ■ Cedar (RAL1011/Pantone 2312C) FD0968 | ■ Ipe (RAL8028/Pantone 4975C)
FD0967 | ■ Teak (RAL8024/ Pantone 469C) FD0970 | ■ Dark Grey (RAL7022/Pantone 425C)



LES 10 POINTS ESSENTIELS

1 STOCKAGE ET MANIPULATION

Le bois composite est une matière sensible au fluage.

- > Il est impératif de stocker les lames toujours à plat. Lors de l'entreposage des palettes de lames, veillez à bien les faire reposer sur toute leur longueur.
- > Gardez la bâche de protection des palettes pendant les travaux comme protection.
- > Evitez de poser des charges sur les palettes de lames.
- > Portez les lames une à une ou deux par deux sur les chants.



2 OUTILLAGE

- > Scie radiale pour tronçonnage posée sur table
- > Visseuse équipée d'un embout de type SR2 (embout fourni dans la boîte de vis)



3 TASSEaux

OSSATURE BOIS > Pose horizontale ou verticale : Chevrons de section 30x40mm minimum en partie courante (double chevrons en jonction de lames) ayant une résistance mécanique correspondant au moins à la classe C18 selon la norme NF EN 338, de durabilité naturelle ou conférée pour la classe d'emploi 2 avec bande de protection ou 3b

Entraxe maximale des chevrons : 600 mm (645 mm sur COB)

OSSATURE METALLIQUE > Pose horizontale ou verticale : ossature et pattes-équerres conformes aux prescriptions du Cahier du CSTB 3194_V2 avec largeur d'appui sur montant de 30 mm minimum.

Entraxe des montants est au maximum de 600 mm

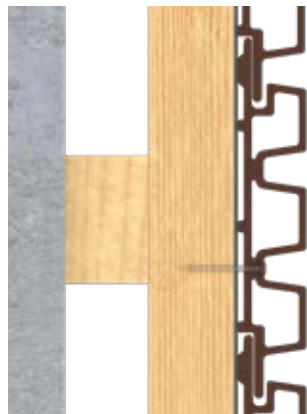

4 DÉCOUPE

- > Chaque lame doit être calibrée avant la pose. Elles peuvent avoir une surcote de 10 mm. Il est donc important de les recouper à la dimension souhaitée pour avoir des joints propres



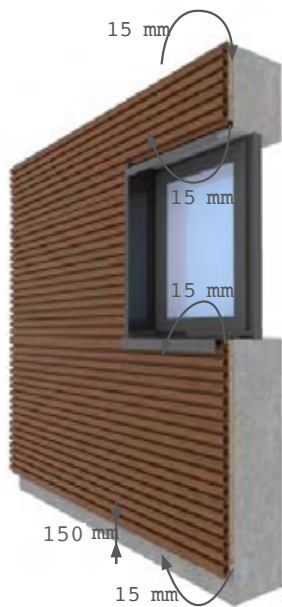

5 VENTILATION

- > Garde au sol : 150mm du sol fini (50mm si sol dur et fixation sur ossature métallique).
- > Ventilation haute et basse (acrotère, tapée & linteau de fenêtre 15 mm).
- > lame d'air entre mur et parement : 20 mm minimum

6 FIXATION SUR SUPPORT BOIS

Vis autoperceuse inox 304 - 4,2 x 38 mm
- filetage bois/aluminium.

- > Couleur de la vis coordonnée à la couleur du bardage.
- > Empreinte = SR2.
- > Tête Ø 8.0 mm.
- > Corps de diamètre Ø 4,2 mm.
- > Longueur sous tête : L = 38 mm.
- > Pointe autoperceuse.
- > Crantage anti foirage sous tête.

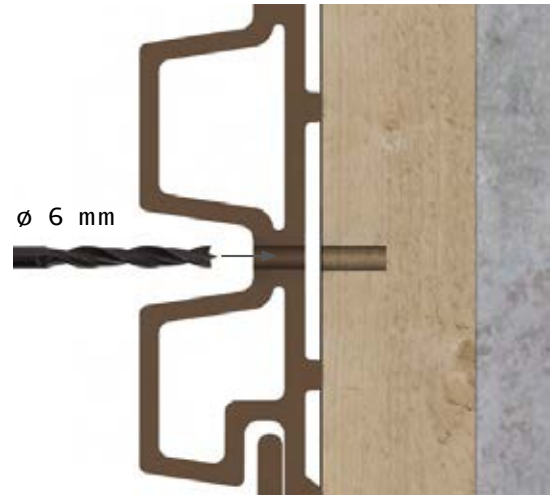
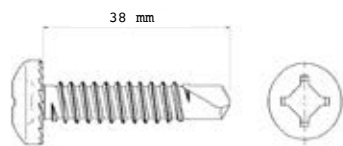

1 - Percage Ø 6 mm.

2 - Prévoir une vis par lame dans un seul fond de gorge en partie courante. Entraxe 600mm.

Prévoir 2 vis (une vis dans chaque fond d'onde) aux points singuliers pour le WEO® 35.

Attention la tête de vis doit venir en appui sur la lame de bardage, mais sans effort, au risque de créer une amorce de fissure. En bout de lame, prévoir un retrait de 15 mm pour éviter tout risque de fissure.

3 - WEO® 60 - En pose verticale : prévoir un vissage dans la gorge de la languette basse pour une fixation invisible par vis 4,2 x 32 mm - Réf. 1337



WEO® 35



WEO® 60

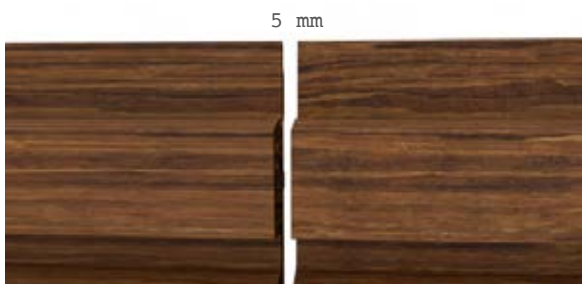
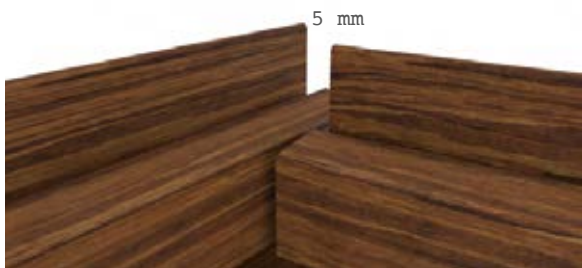

7 DILATATION

> Les lames WEO® ont un coefficient de dilatation de 1mm/ml (pour un gradient de température de 40°C) Exemple : une lame de 3,9 m rencontrant une température de 5°C le matin et 40°C l'après midi aura une dilatation de 3,15 mm.

> Respecter entre chaque extrémité de lame et tous les types d'obstacles rencontrés (menuiserie, mur, angle, lame ..) un jeu de 5 mm.

8 SENS DE POSE DES LAMES WEO® 35 / WEO® 60

Pose à l'horizontale :

- > La rainure est en position basse et la languette en position haute.
- > Vissage dans le creux d'ondes pour la première lame en partie basse.

Pose à la verticale :

- > Pas de sens particulier.

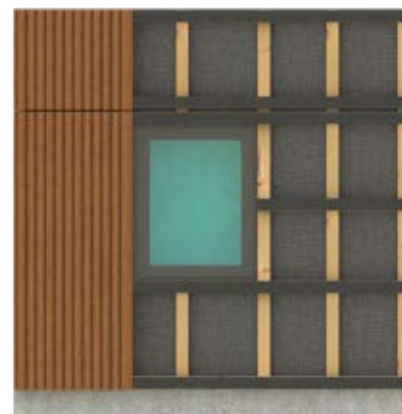

9 FINITIONS

> Nous conseillons l'utilisation de profils en aluminium laqué pour réaliser les finitions.

> L'ensemble des profils de finition nécessaires à réaliser (les cornières d'angles rentrant et sortant, les abouts de bardage, profil sous bardage, tableau de menuiserie, joint de dilatation vertical ou horizontal) est détaillé dans ce guide de pose.

> Les plans sont fournis selon les caractéristiques à respecter, et certains éléments ont des dimensions variables à adapter en fonction de l'ouvrage. Les profils doivent être fabriqués à la demande chez des spécialistes du pliage de tôle fine et en tenant compte des particularités de l'ouvrage. Nous ne fournissons que le profil d'angle sortant (P.14).

10 VIEILLISSEMENT & ENTRETIEN

Le film protecteur en polyéthylène issu du procédé de co-extrusion garantit une tenue aux UV de 20 ans sans décoloration apparente. Un nettoyage à l'eau (nettoyeur haute pression) peut être réalisé selon l'exposition des façades et des dépôts de saletés.

PROFILS & ACCESSOIRES

1 - DESCRIPTIF DU BARDAGE WEO®

Le bardage WEO® est un système de bardage rapporté à faux claire-voie, conforme à la norme EN 15534. Il est conçu en bois reconstitué, composé de 60% de fibres de bois issues de produits connexes d'usine de seconde transformation du bois et de 40% de polyéthylène recyclé. Il présente en surface un aspect mat brossé, avec une pigmentation multi-chromatique.

Les lames de bardage WEO® 35 sont composées de 3 ondes de 36 mm et les lames de bardage WEO® 60 sont composées de 2 ondes de 59 mm. Elles sont proposées dans 4 couleurs : Cedar, Ipe, Teak, Dark Grey.

Elles peuvent être posées en position horizontale ou verticale sur des parois planes. La fixation se fait en fond d'onde par vis avec tête laquée, teintée sur le RAL approchant de type SFS. WEO® 60 en pose verticale, se fixe dans la gorge de la languette bosse.

Une lame d'air ventilée, de 20 mm minimum, est ménagée entre la face interne des lames et le nu extérieur du mur porteur ou de l'isolant thermique éventuel.

Pour des longueurs complètes de 2.90m et 3.90m, un entraxe de 300mm sera nécessaire en bout de lames pour permettre l'aboutage au droit du tasseau.

2 - CARACTÉRISTIQUES DIMENSIONNELLES

WEO® 35

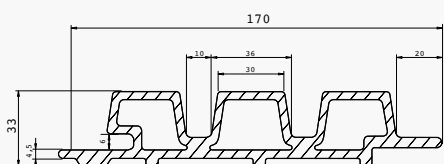

Longueur standard	2900 mm	3900 mm
Surface d'une lame (utile)	0,406 m ²	0,546 m ²
Masse surfacique	15 kg/m ²	15 kg/m ²
Largeur hors tout	170 mm	170 mm
Largeur utile	140 mm	140 mm
Nb de vis / m ² (entraxe 600 mm)	12	12
Nb de vis / lame (entraxe 600 mm)	5	7

WEO® 60

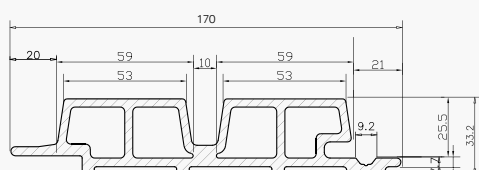

Longueur standard	2900 mm	3900 mm
Surface d'une lame (utile)	0,406 m ²	0,546 m ²
Masse surfacique	14,5 kg/m ²	14,5 kg/m ²
Largeur hors tout	170 mm	170 mm
Largeur utile	140 mm	140 mm
Nb de vis / m ² (entraxe 600 mm)	12	12
Nb de vis / lame (entraxe 600 mm)	5	7

POSE
WEO® 35

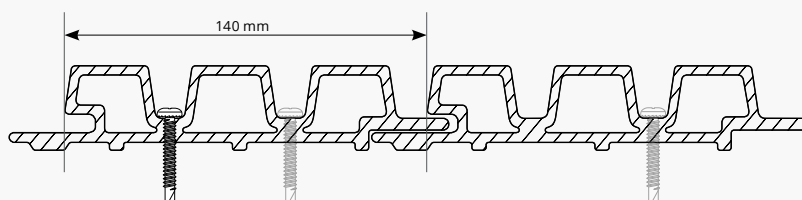

POSE
WEO® 60

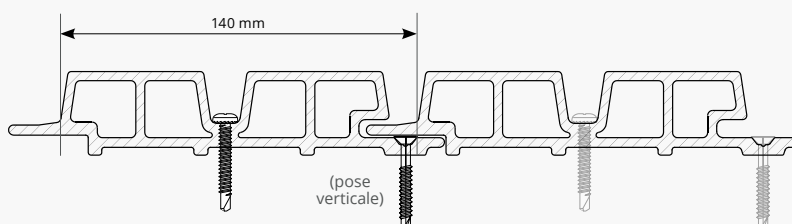



1 - GAMME 09

2 - POSE VERTICALE SUR TOUS SUPPORTS WEO® 35 10

- Vue Générale
- Pied de mur et Acrotère
- Linteau et tablette
- Tableau métal menuiserie
- Angle sortant
- Angle rentrant
- Joint horizontal
- Fractionnement et coupure lame d'air
- About de bardage
- Joint de dilatation vertical
- Remplacement de lame

3 - POSE HORIZONTALE SUR TOUS SUPPORTS WEO® 35 21

- Vue Générale
- Pied de mur et Acrotère
- Linteau et tablette
- Tableau métal menuiserie

- Angle sortant
- Angle rentrant
- Joint Vertical
- Fractionnement et coupure lame d'air
- About de bardage
- Joint de dilatation vertical
- Remplacement de lame

4 - POSE SUR CONSTRUCTION OSSATURE BOIS WEO® 35 32

5 - POSE SUR OSSATURE METALLIQUE WEO® 35 33

6 - POSE BARDAGE WEO® 60 35

- Vue Générale
- Pied de mur et Acrotère
- Angle sortant et rentrant
- Remplacement de lame
- Compatibilité profil Weo® 35 / Weo® 60

1- GAMME

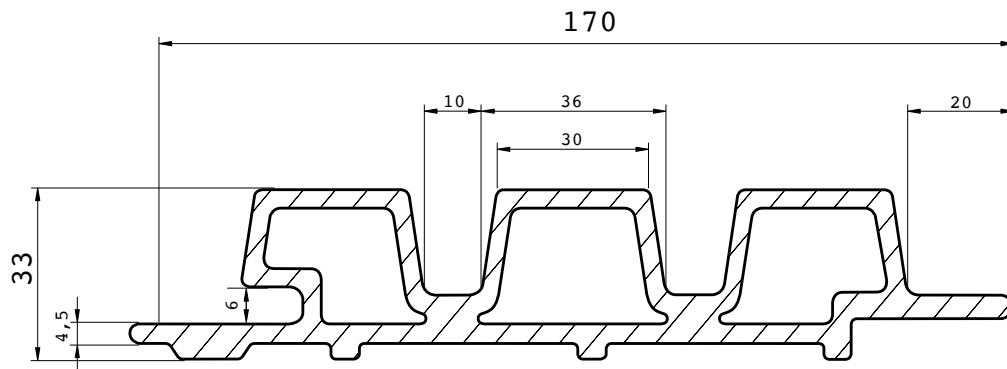

WEO® 35

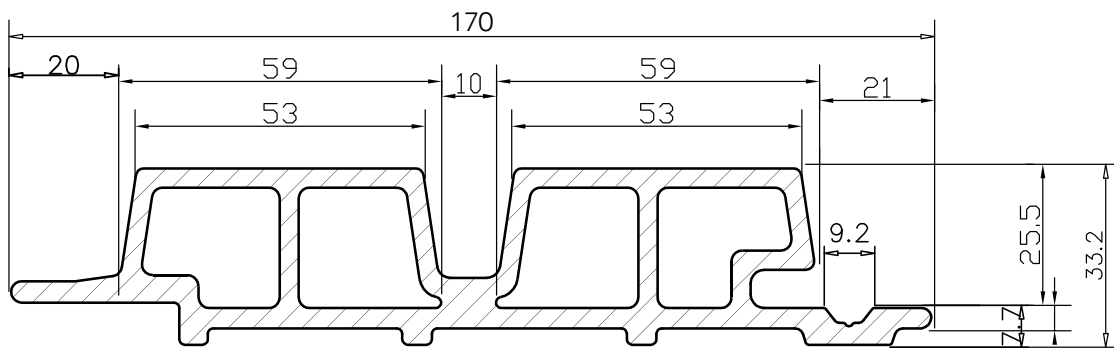

WEO® 60

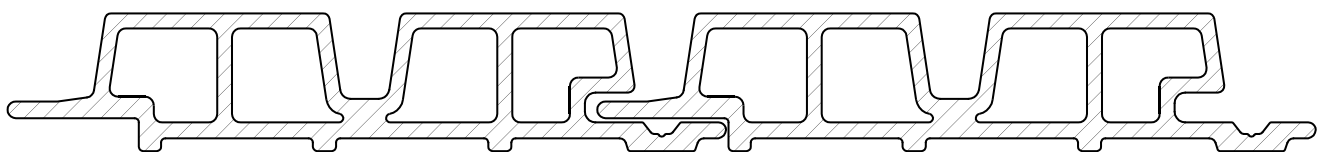
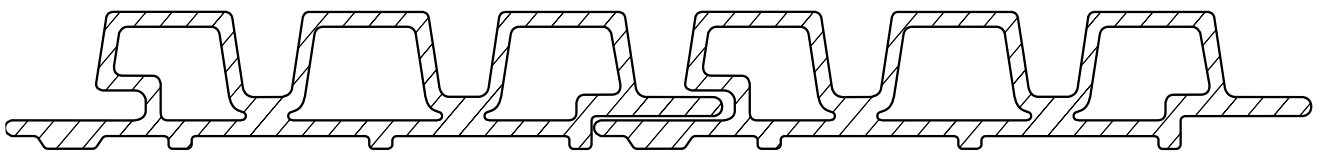

2 - POSE VERTICALE SUR TOUS SUPPORTS WEO® 35

2.1 - VUE GÉNÉRALE

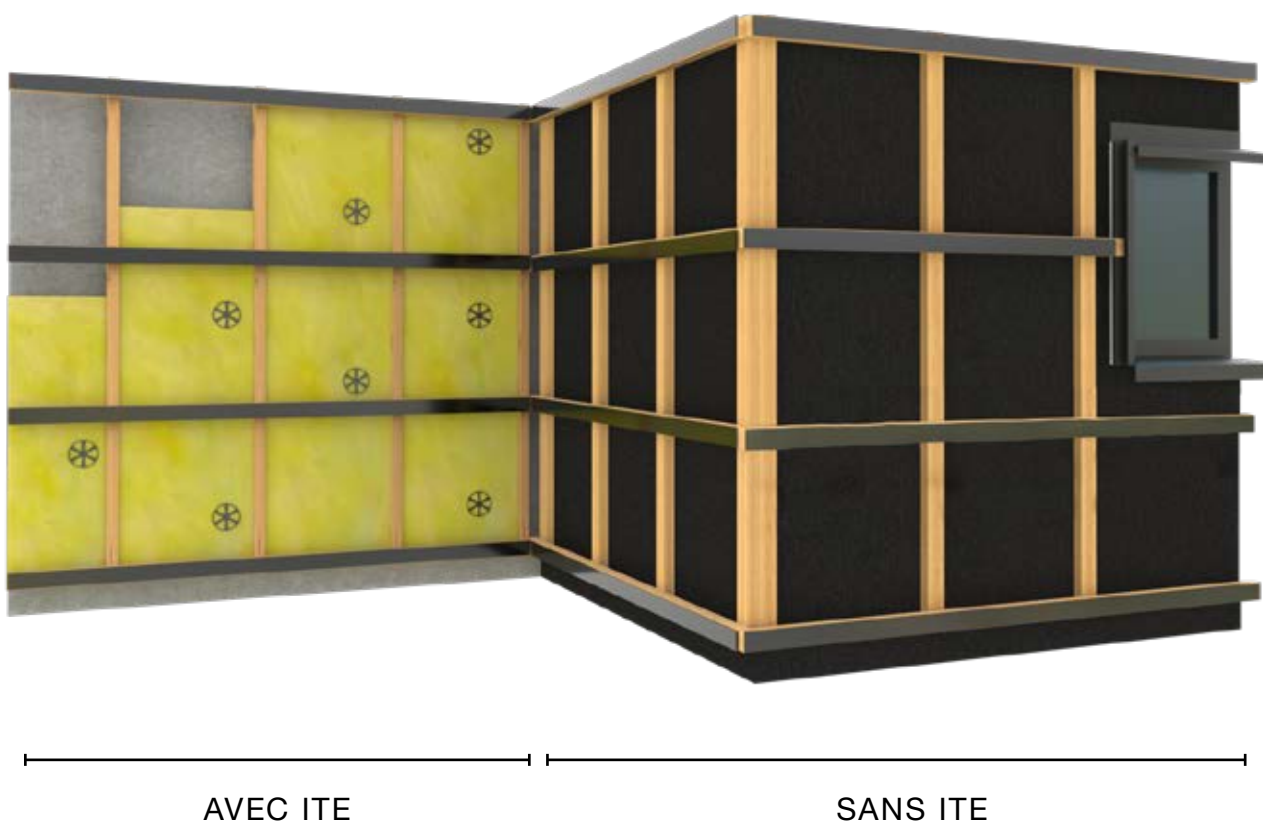

2 - POSE VERTICALE SUR TOUS SUPPORTS WEO® 35

2.2 - PIED DE MUR ET ACROTÈRE WEO® 35

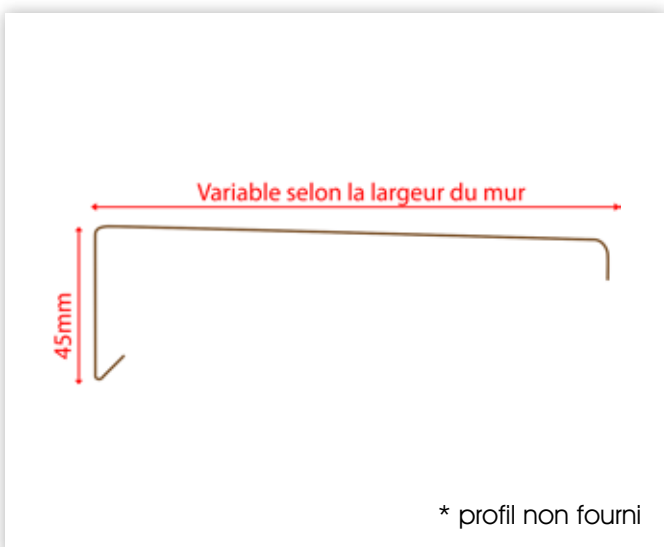
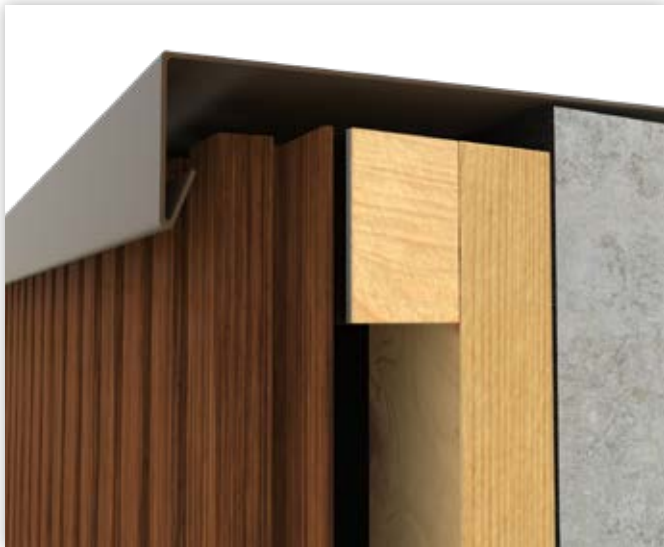

* profil non fourni

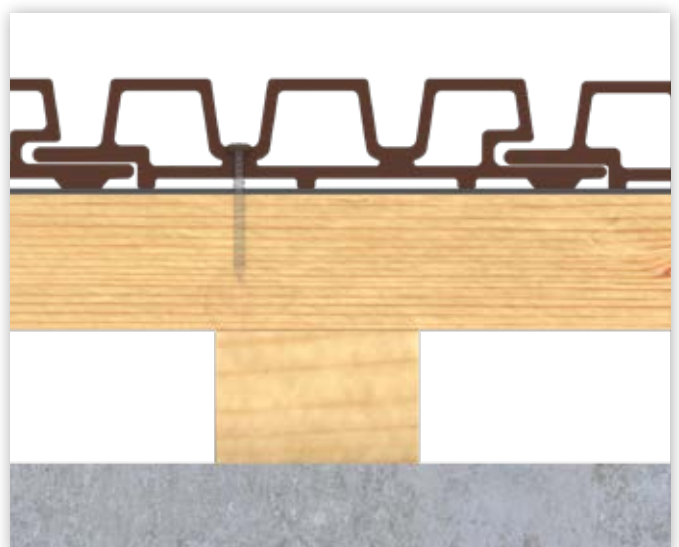

2 - POSE VERTICALE SUR TOUS SUPPORTS WEO® 35

2.3 - LINTEAU ET TABLETTE

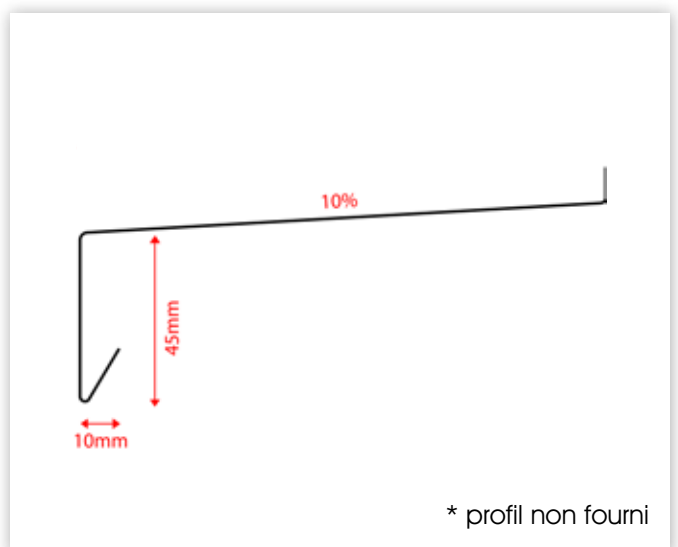
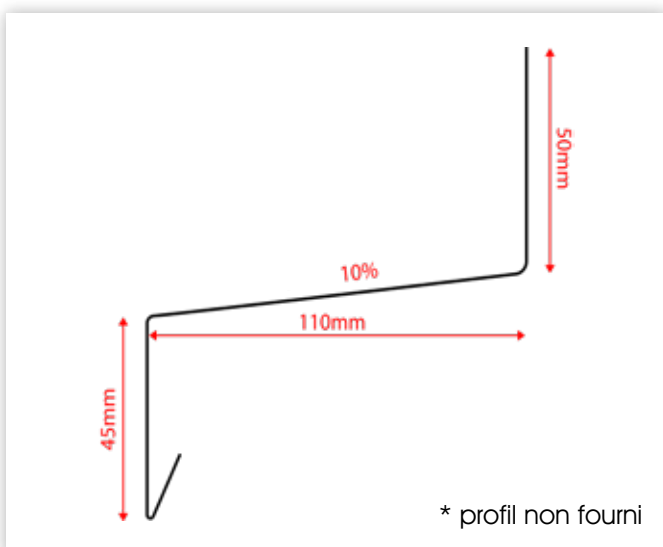
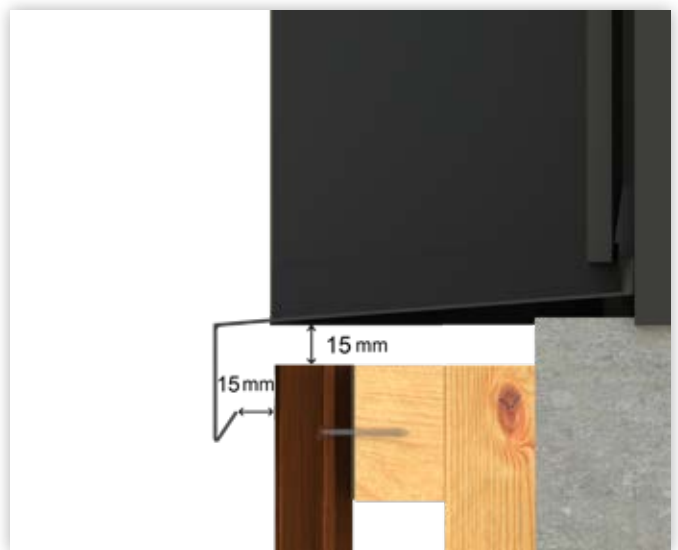
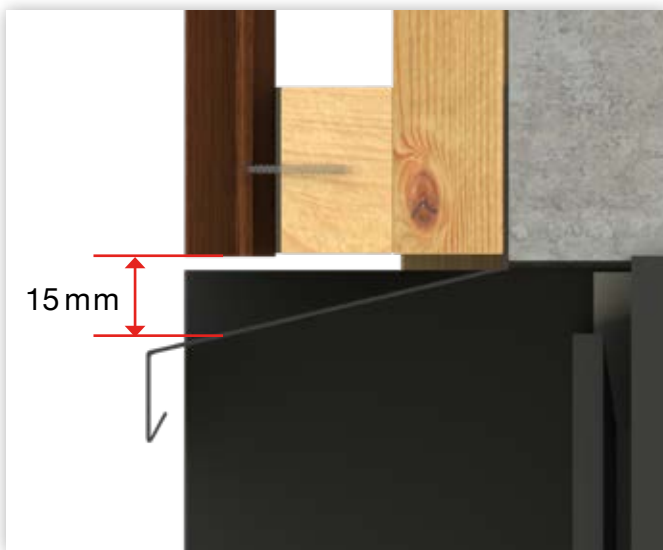
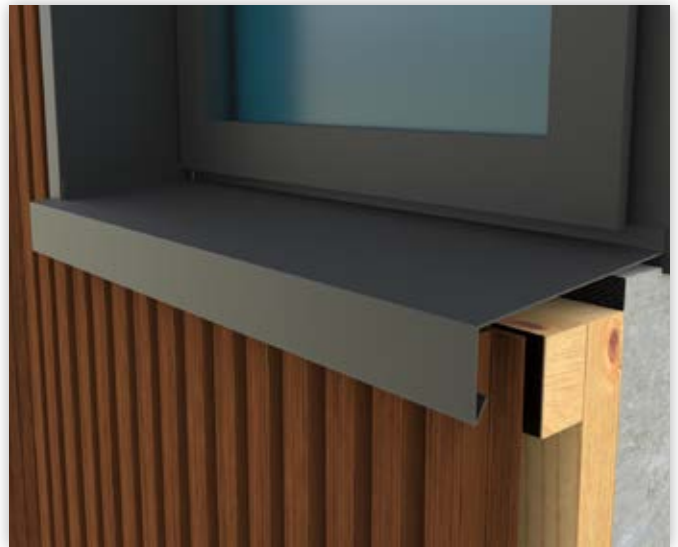
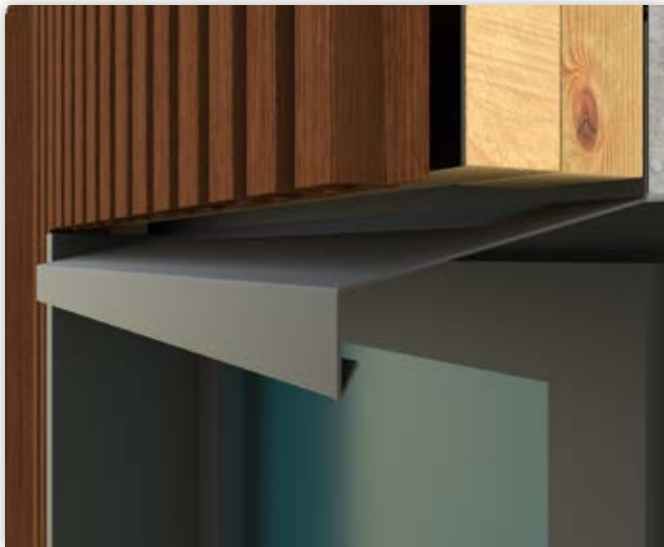

2 - POSE VERTICALE SUR TOUS SUPPORTS WEO® 35

2.4 - TABLEAU MÉTAL MENUISERIE

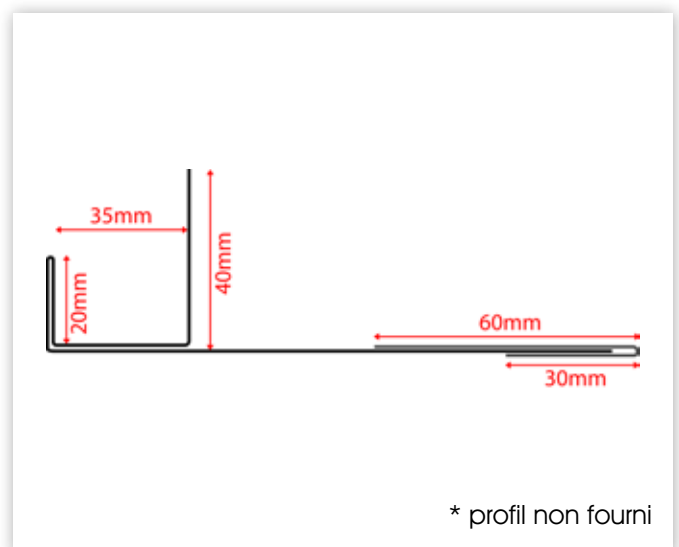
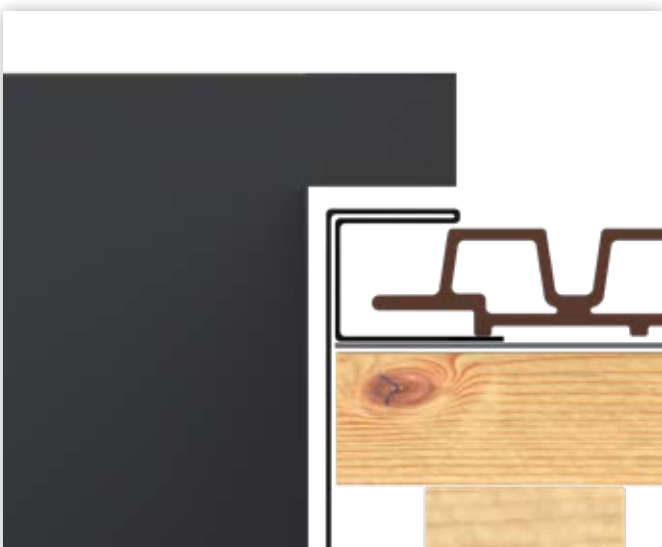

2 - POSE VERTICALE SUR TOUS SUPPORTS WEO® 35

2.5 - ANGLE SORTANT AVEC COUVRE JOINT

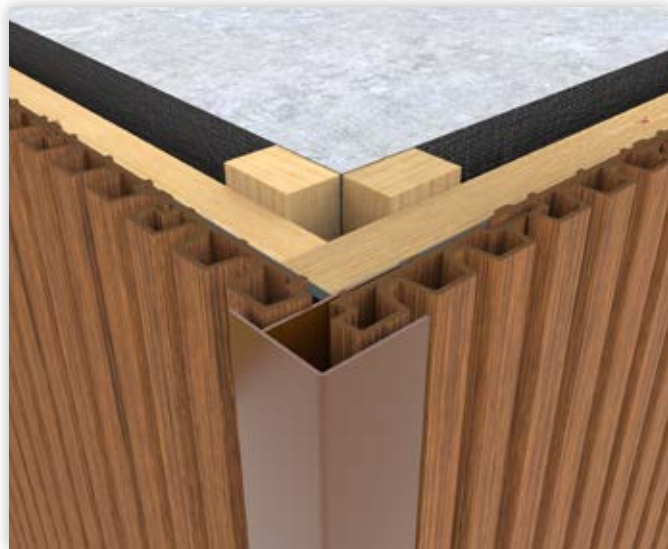

2.5.1 - ANGLE SORTANT SANS COUVRE JOINT

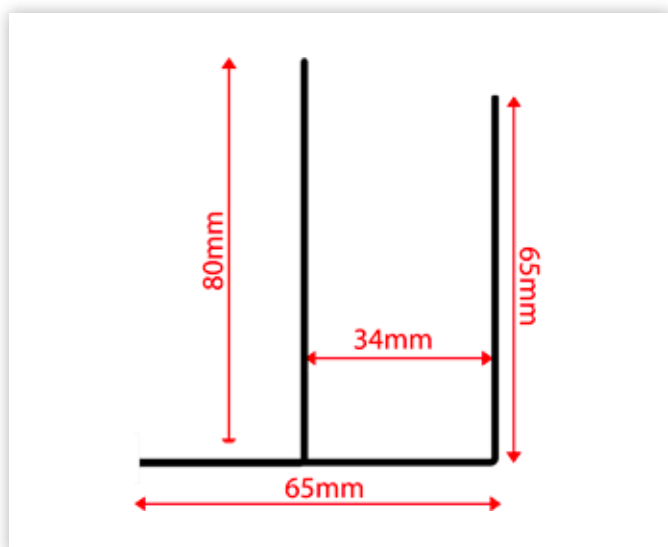
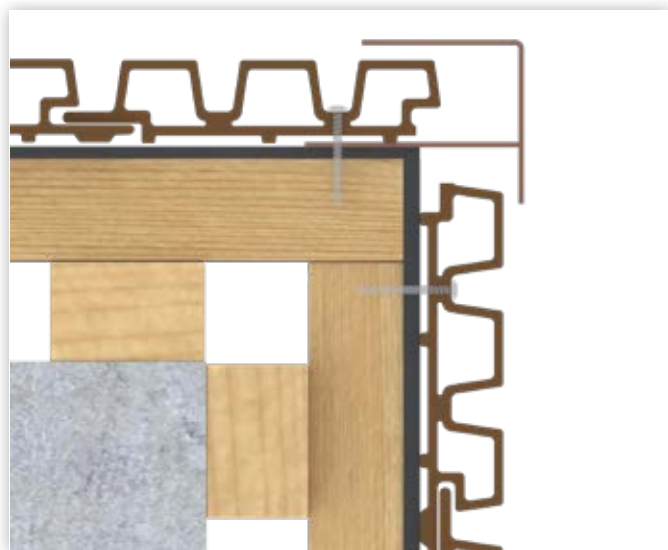
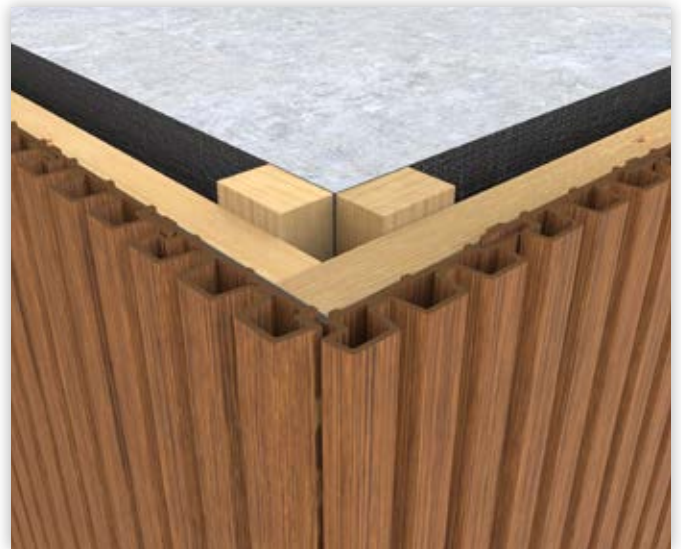

2 - POSE VERTICALE SUR TOUS SUPPORTS WEO® 35

2.6 - ANGLE RENTRANT AVEC COUVRE JOINT

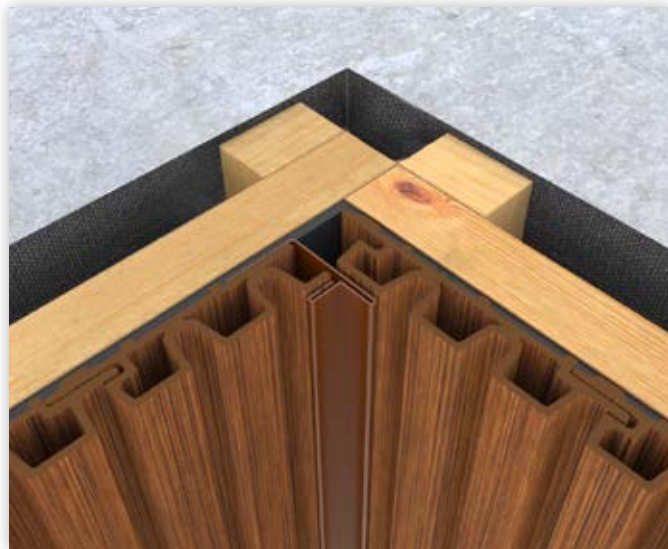

2.6.1 - ANGLE RENTRANT SANS COUVRE JOINT

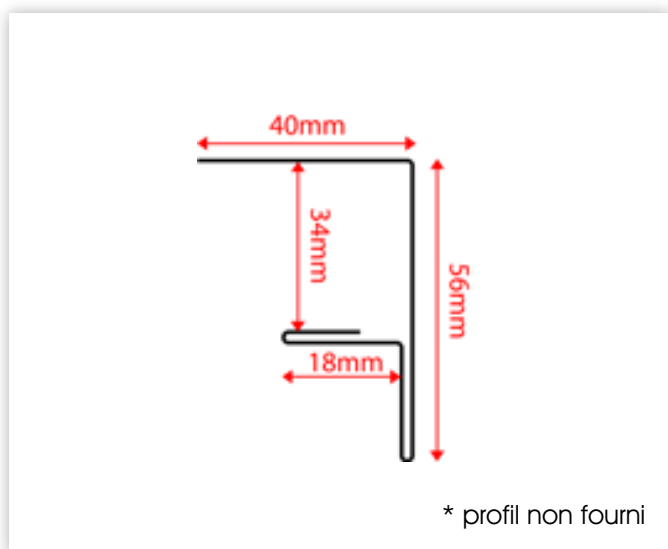
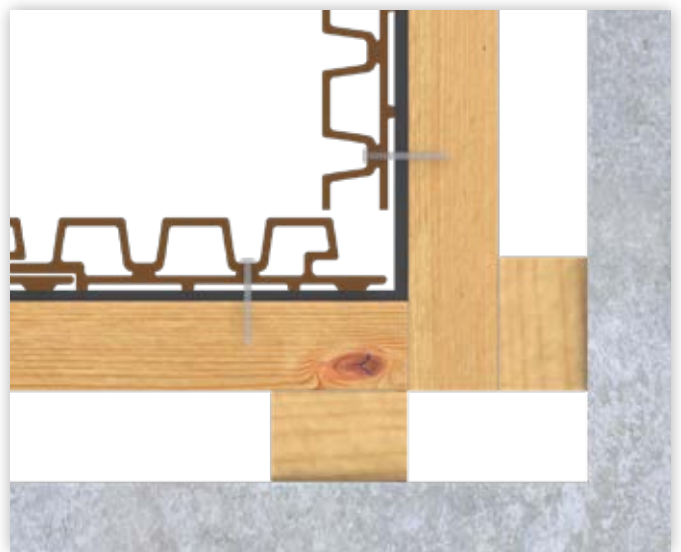
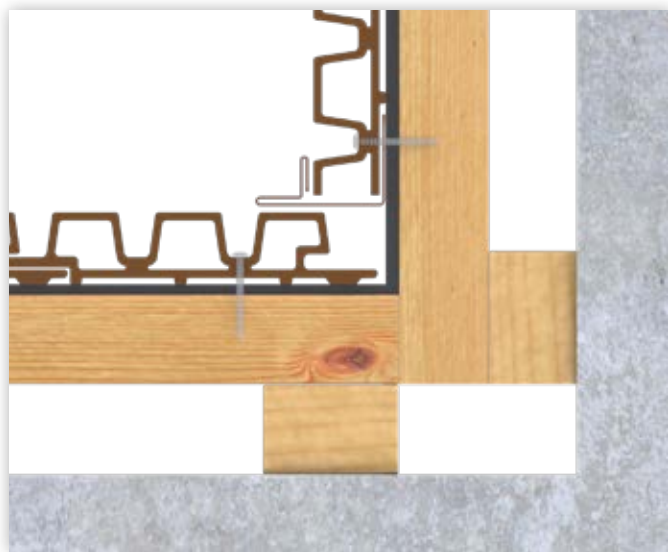



2 - POSE VERTICALE SUR TOUS SUPPORTS WEO® 35

2.7 - JOINT HORIZONTAL



2 - POSE VERTICALE SUR TOUS SUPPORTS WEO® 35

2.8 - FRACTIONNEMENT ET COUPURE LAME D'AIR

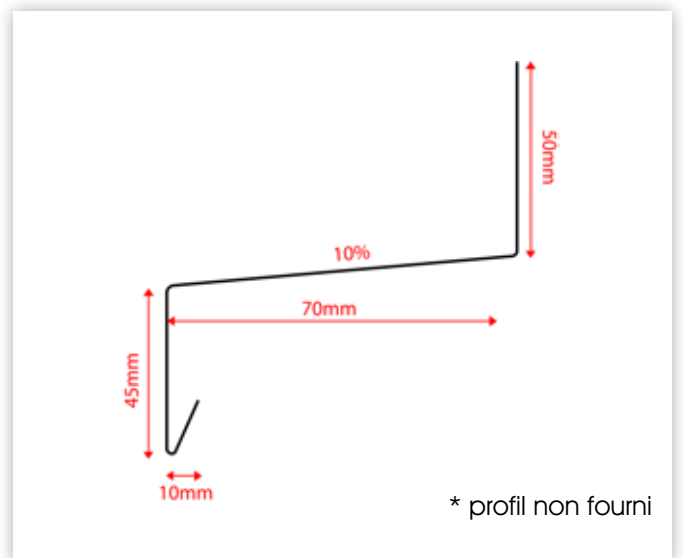

2 - POSE VERTICALE SUR TOUS SUPPORTS WEO® 35

2.9 - ABOUT DE BARDAGE

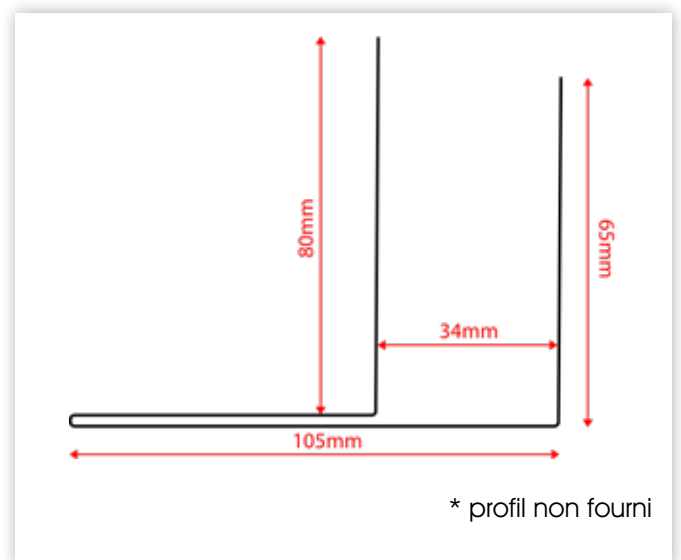
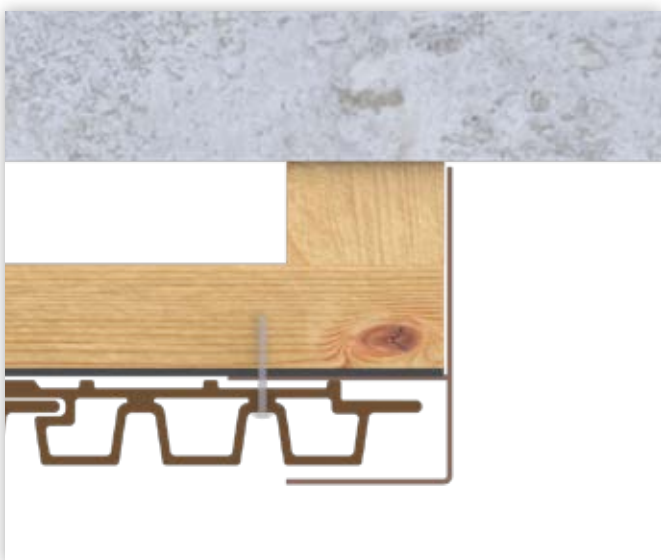
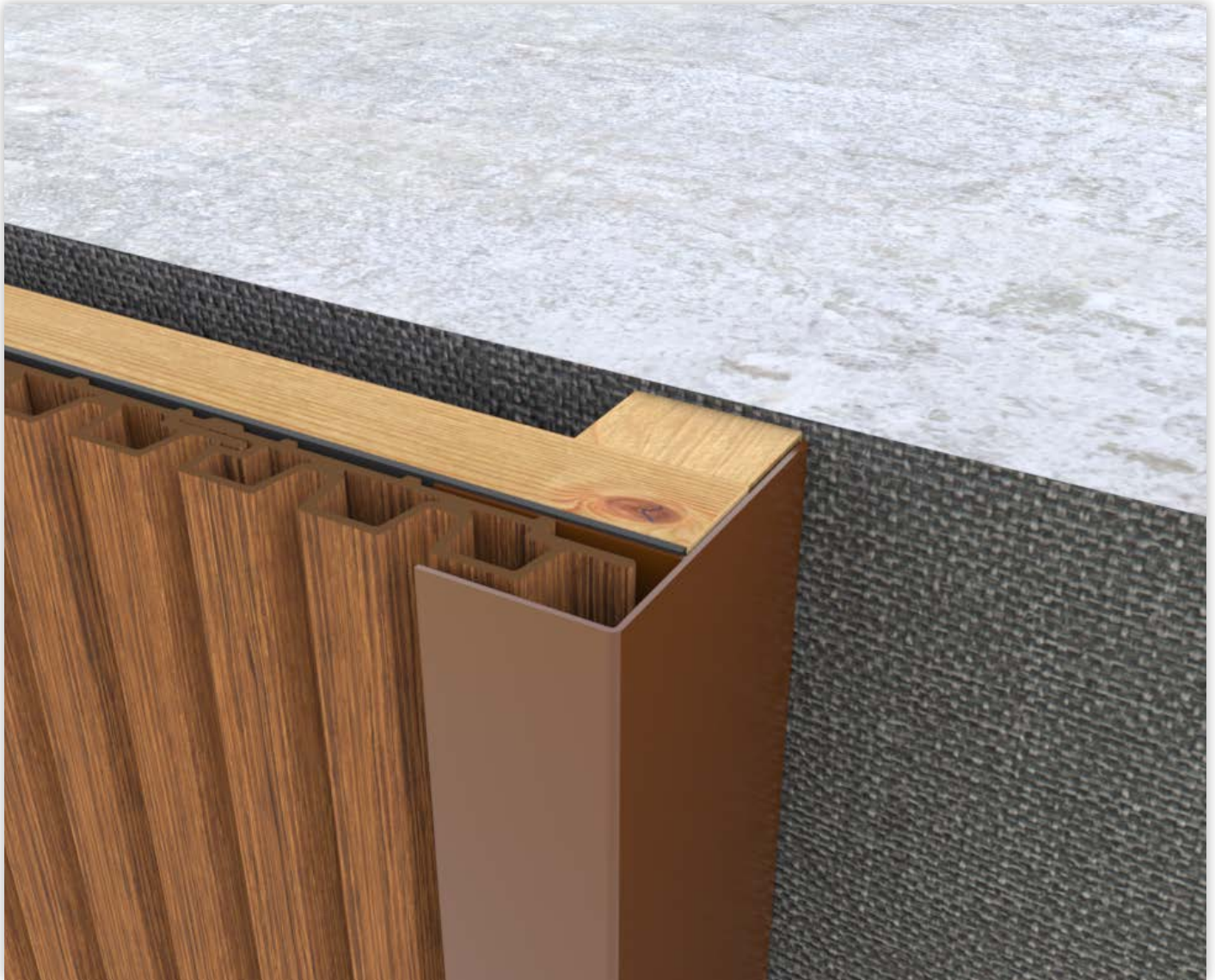

2 - POSE VERTICALE SUR TOUS SUPPORTS WEO® 35

2.10 - JOINT DE DILATATION VERTICAL

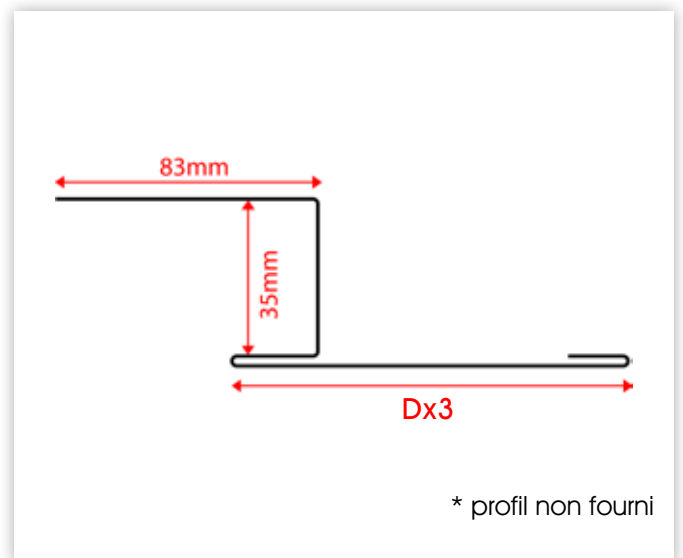
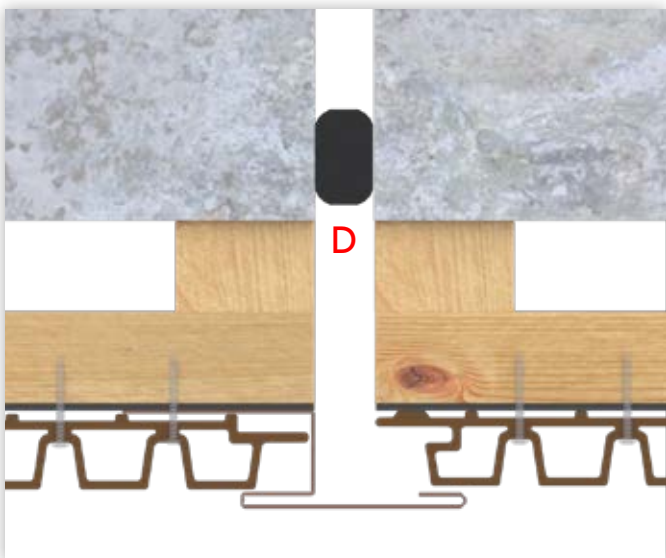

2 - POSE VERTICALE SUR TOUS SUPPORTS WEO® 35

2.11 - REMPLACEMENT DE LAME

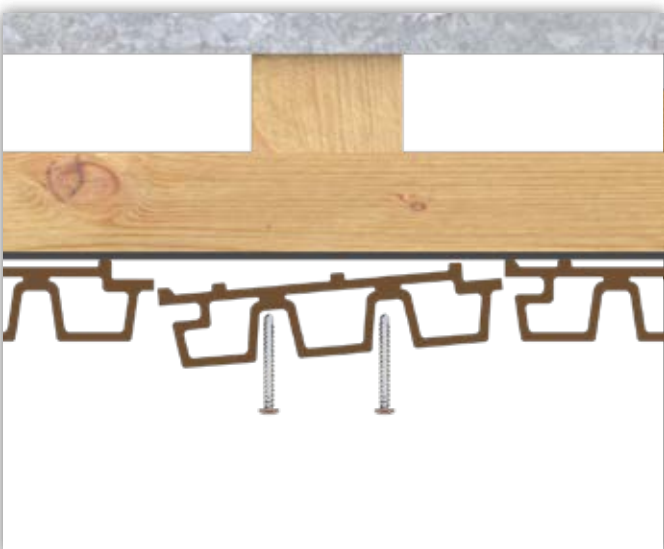
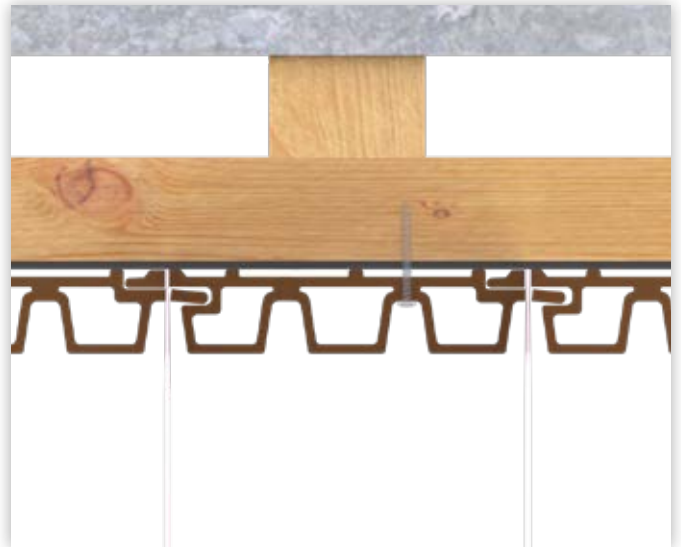

3 - POSE HORIZONTALE SUR TOUS SUPPORTS WEO® 35

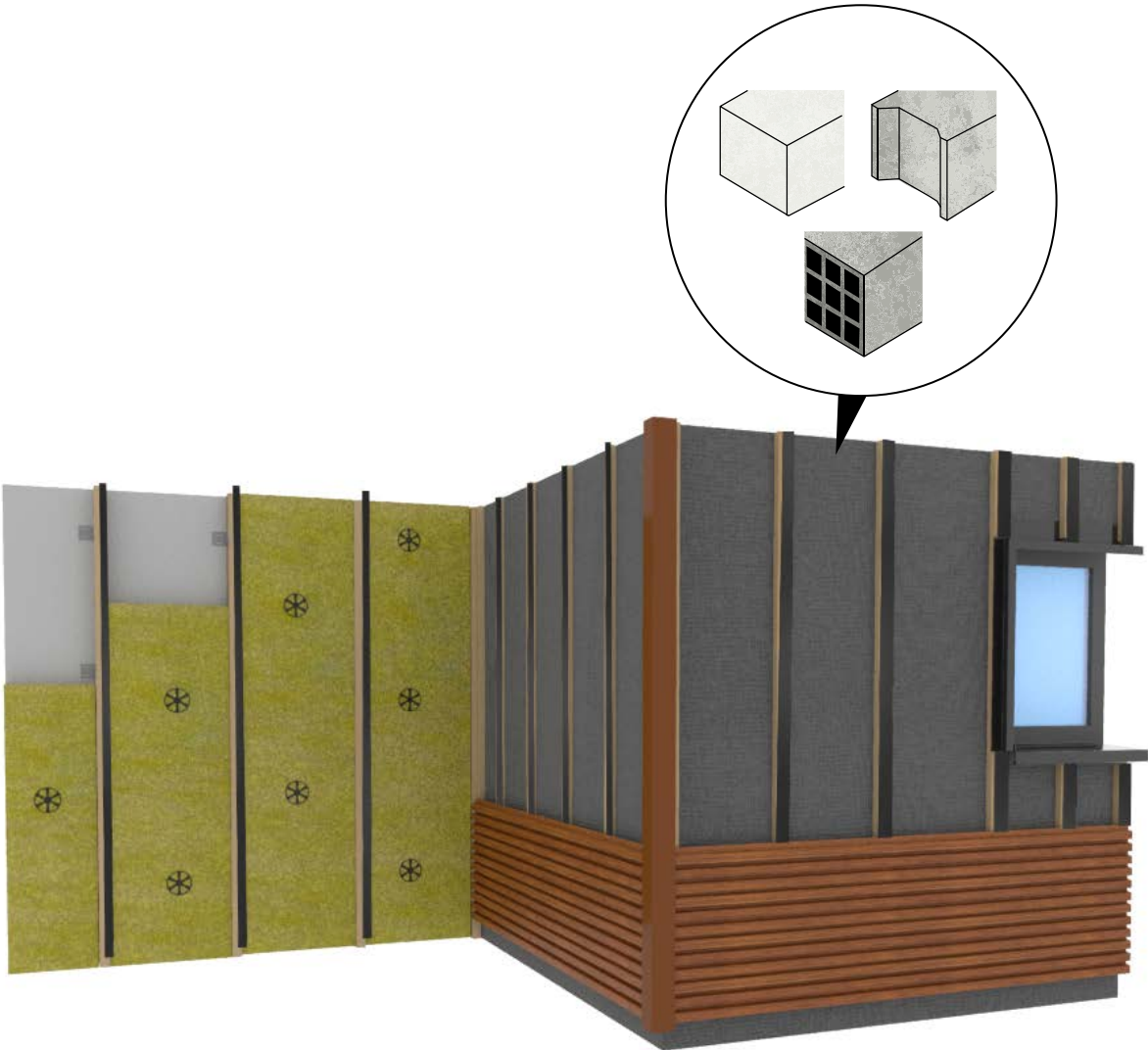

3 - POSE HORIZONTALE SUR TOUS SUPPORTS WEO® 35

3.2 - PIED DE MUR ET ACROTÈRE

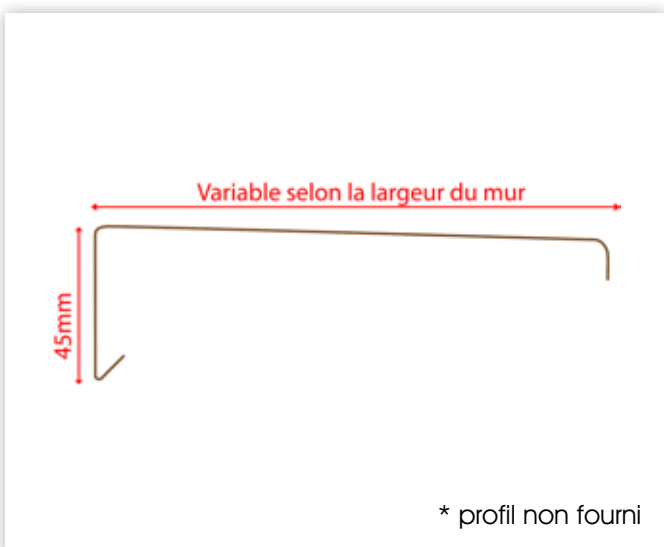
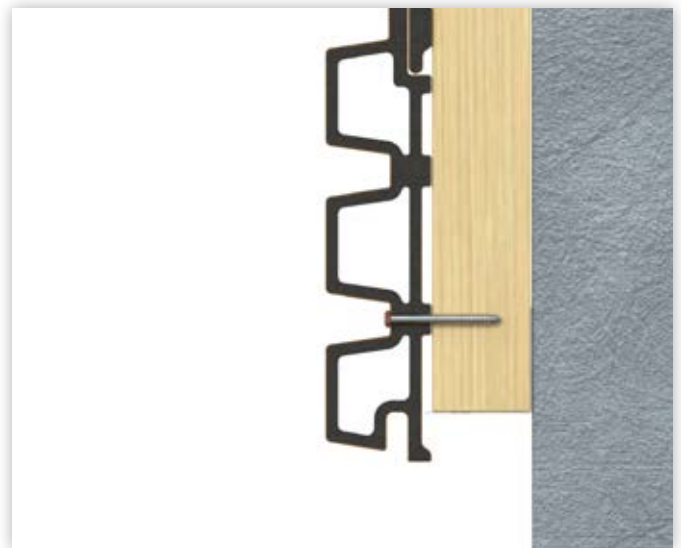
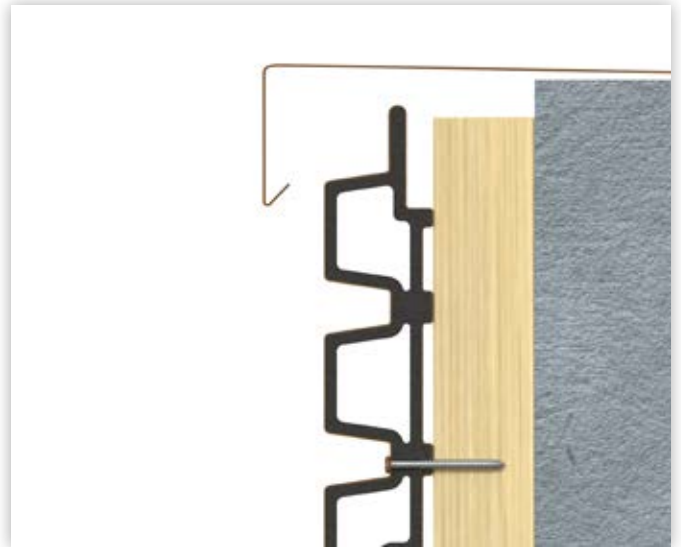

3 - POSE HORIZONTALE SUR TOUS SUPPORTS WEO® 35

3.3 - LINTEAU ET TABLETTE

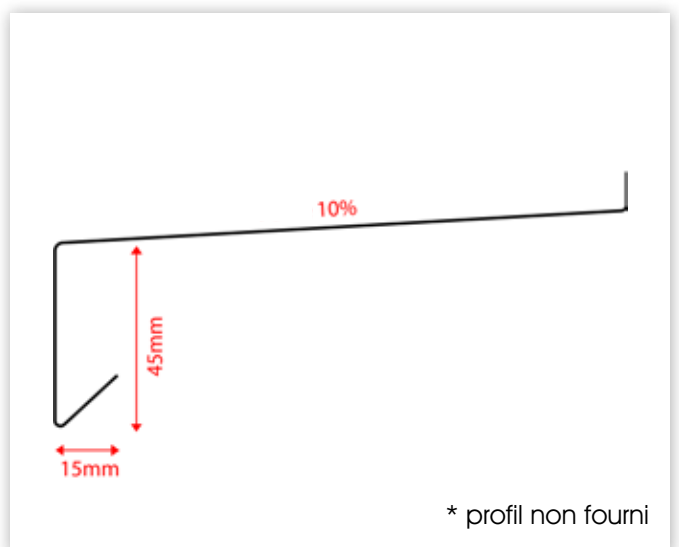
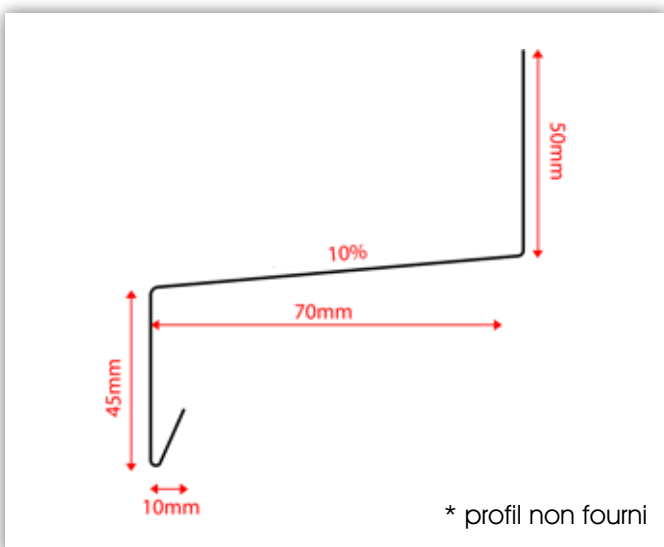

3 - POSE HORIZONTALE SUR TOUS SUPPORTS WEO® 35

3.4 - TABLEAU MÉTAL MENUISERIE

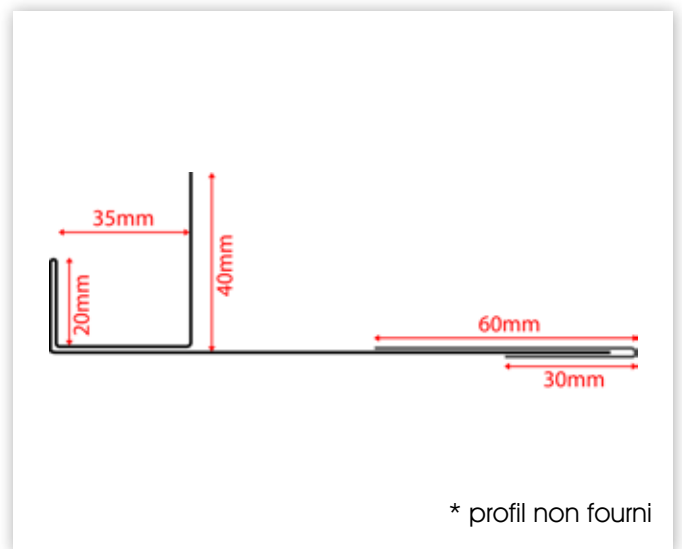
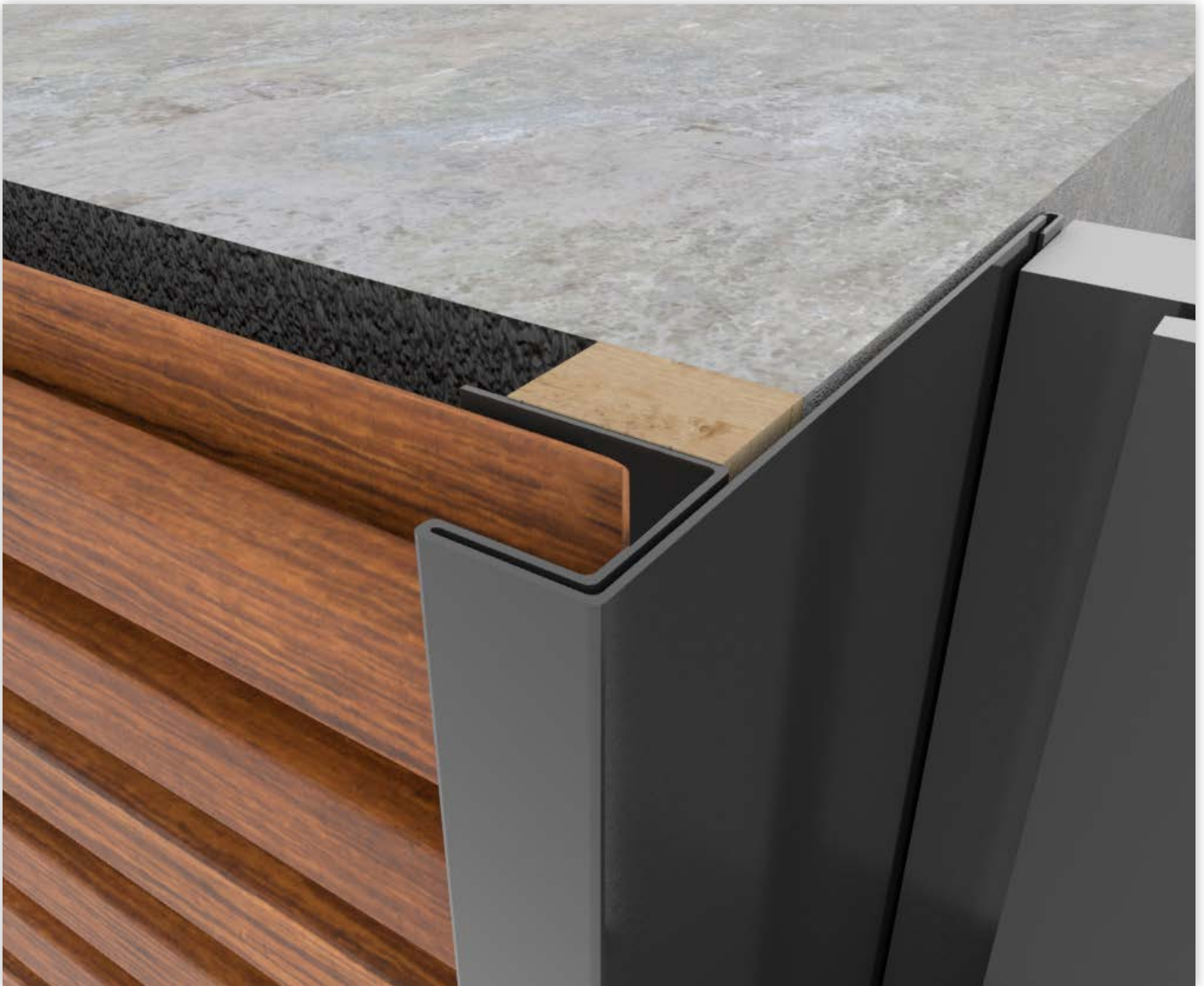

3 - POSE HORIZONTALE SUR TOUS SUPPORTS WEO® 35

3.5 - ANGLE SORTANT

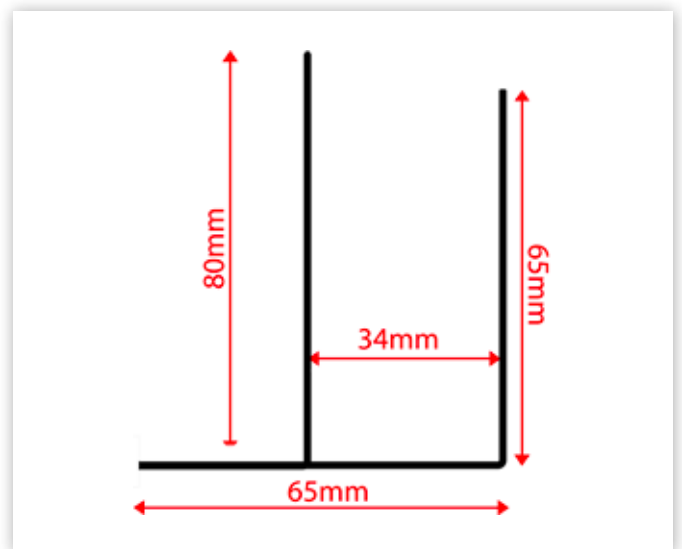
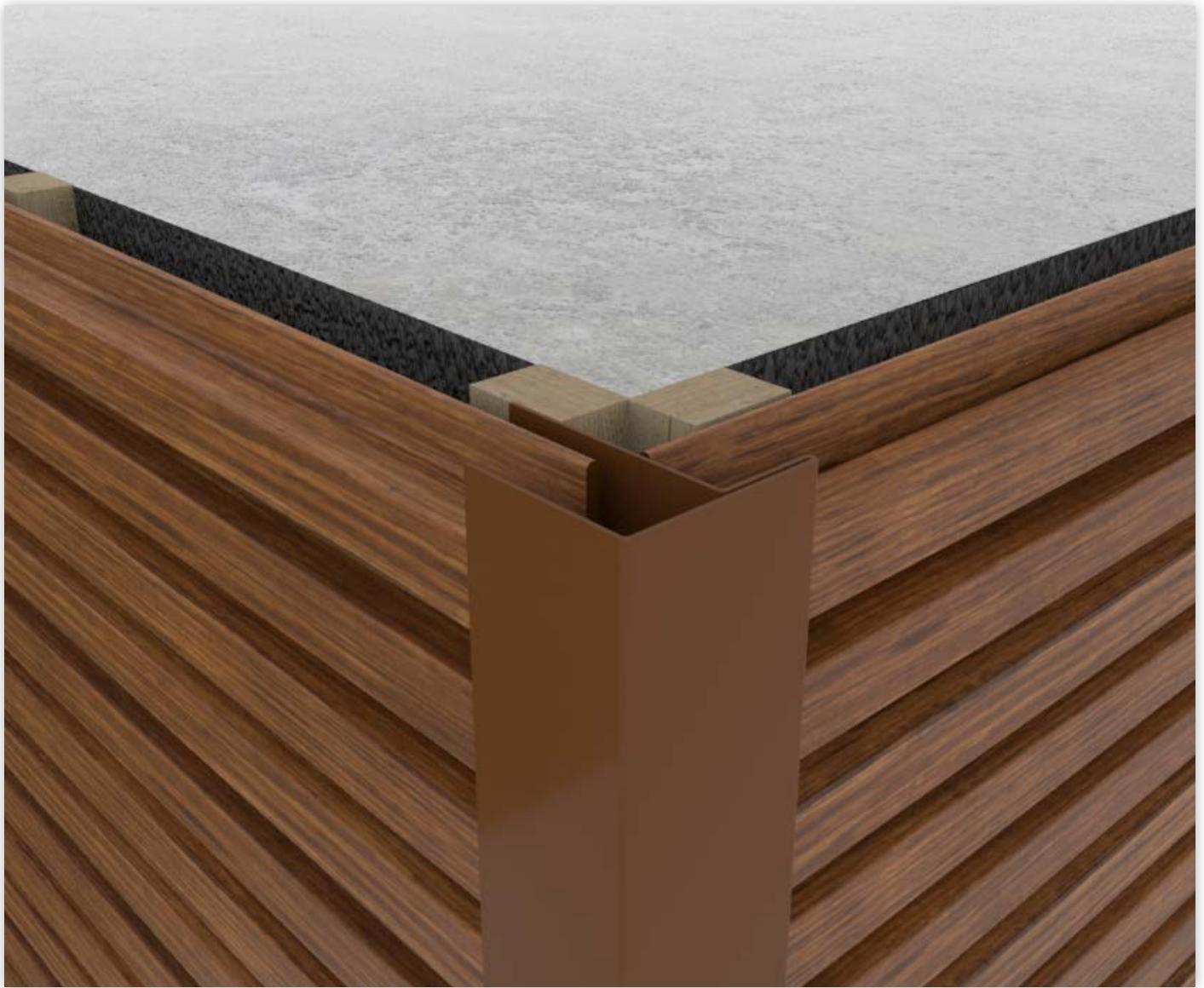

3 - POSE HORIZONTALE SUR TOUS SUPPORTS WEO® 35

3.6 - ANGLE RENTRANT AVEC COUVRE JOINT

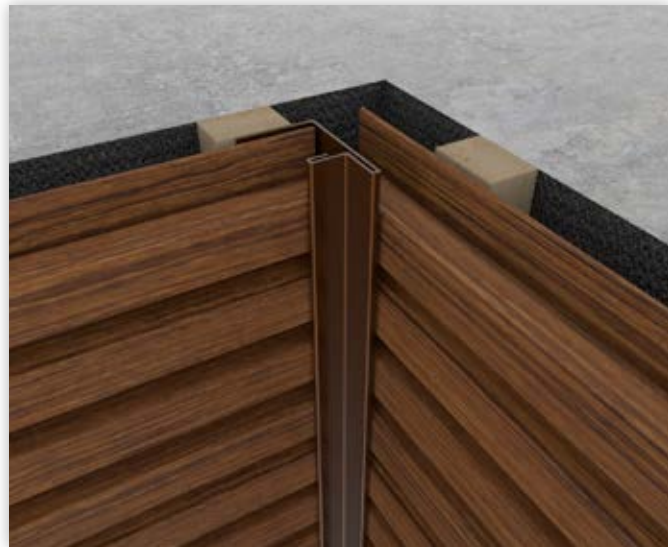

3.6.1 - ANGLE RENTRANT SANS COUVRE JOINT

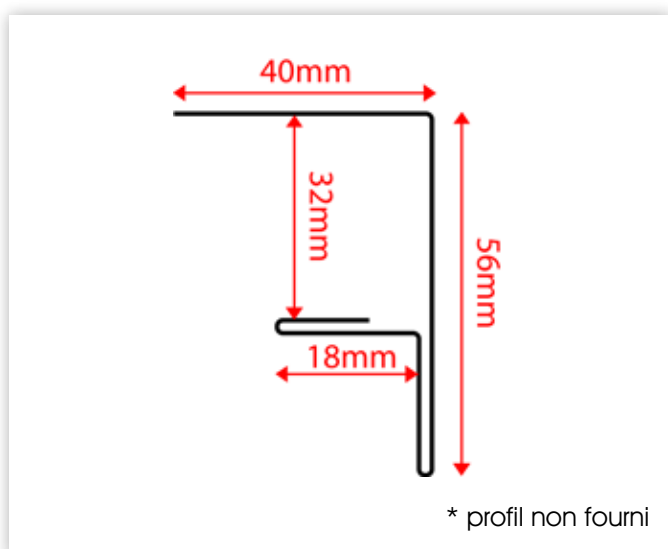
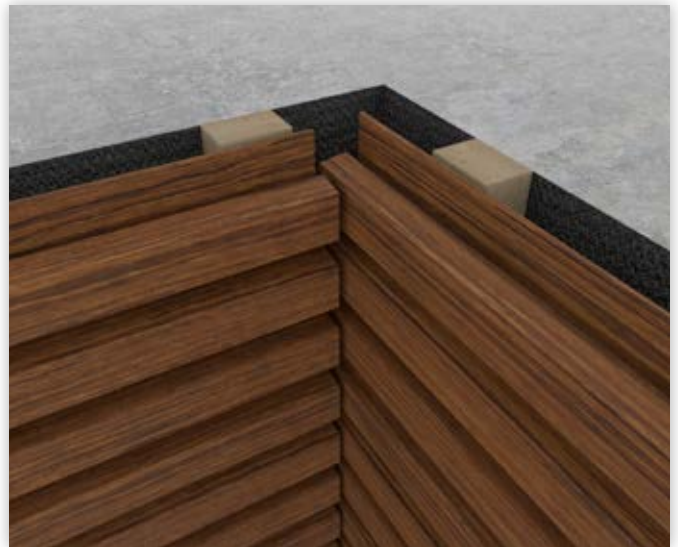

3 - POSE HORIZONTALE SUR TOUS SUPPORTS WEO® 35

3.7 - JOINT VERTICAL

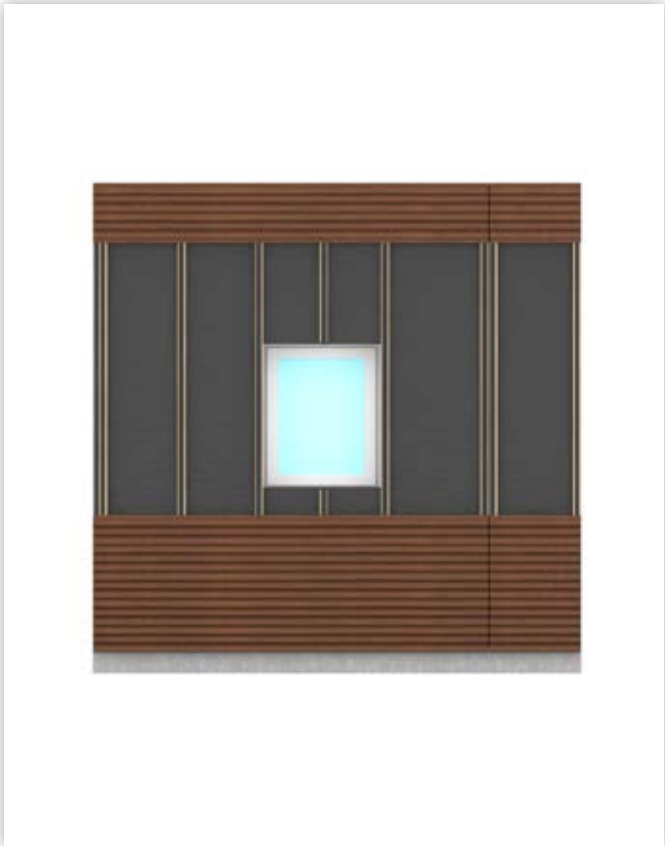

3 - POSE HORIZONTALE SUR TOUS SUPPORTS WEO® 35

3.8 - FRACTIONNEMENT ET COUPURE LAME D'AIR

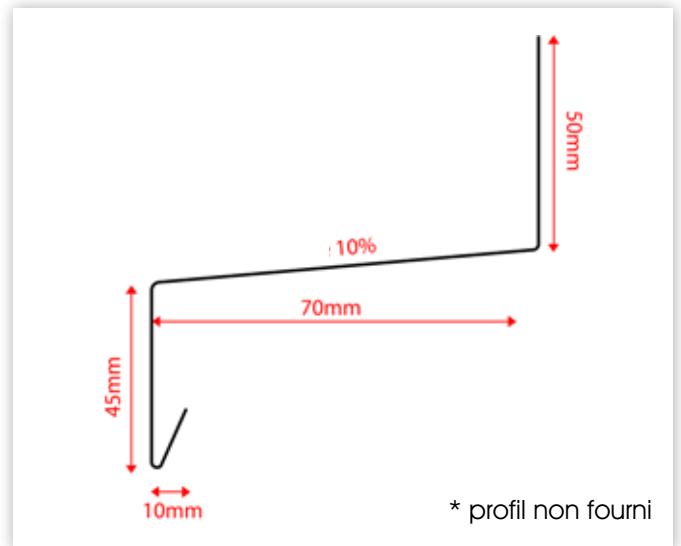
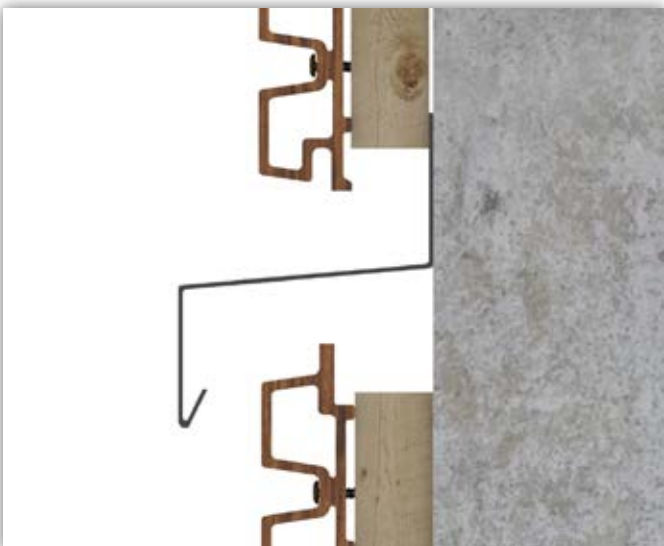

3 - POSE HORIZONTALE SUR TOUS SUPPORTS WEO® 35

3.9 - ABOUT DE BARDAGE

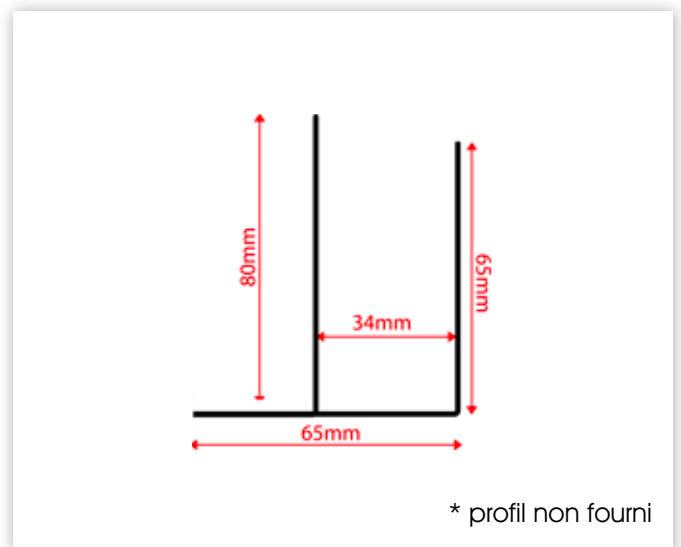
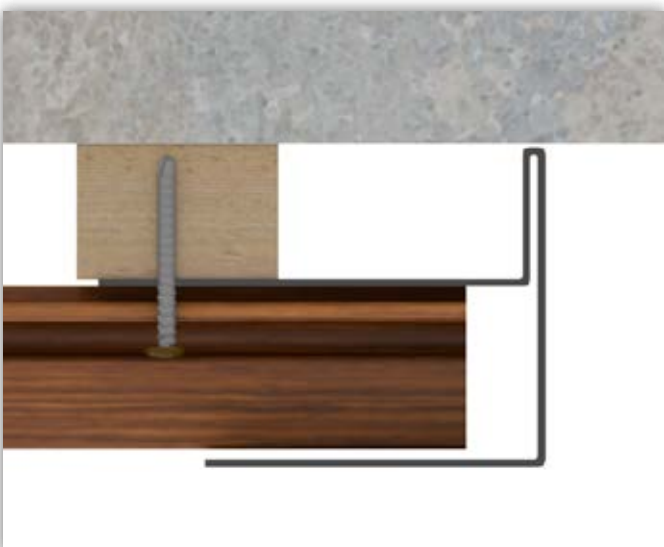

3 - POSE HORIZONTALE SUR TOUS SUPPORTS WEO® 35

3.10 - JOINT DE DILATATION VERTICAL

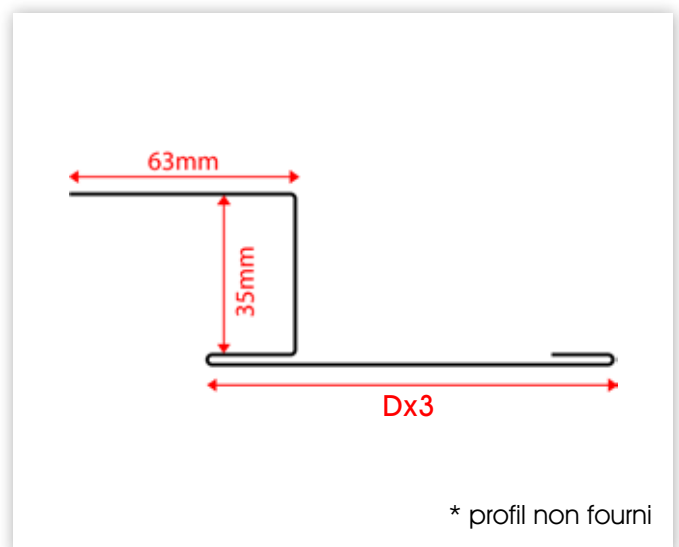
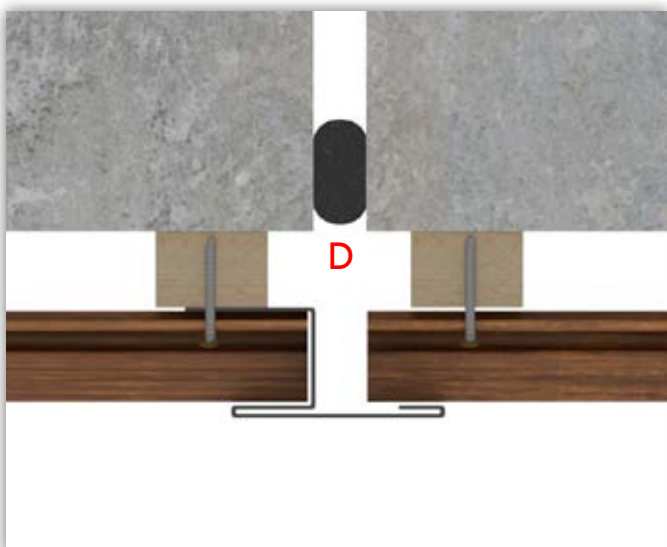

3 - POSE HORIZONTALE SUR TOUS SUPPORTS WEO® 35

3.11 - REMPLACEMENT DE LAME

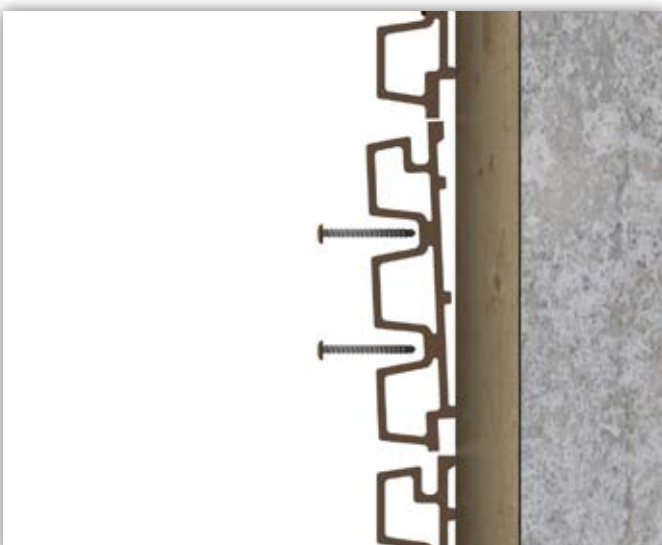
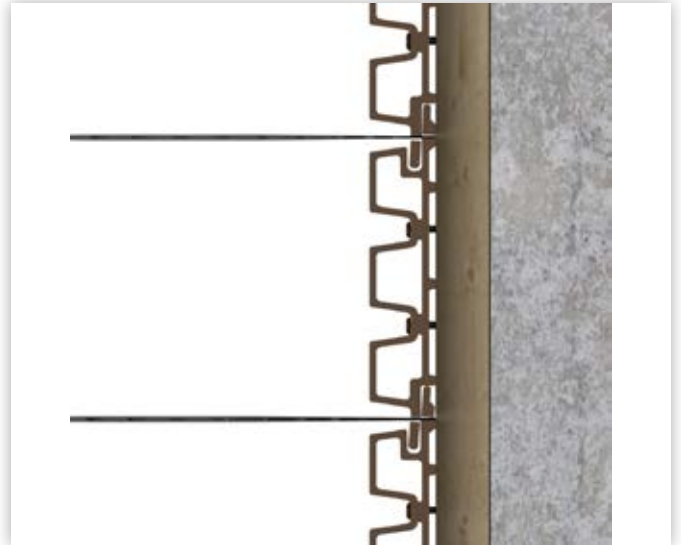

4 - POSE SUR CONSTRUCTION OSSATURE BOIS WEO® 35

4.1 - POSE HORIZONTALE

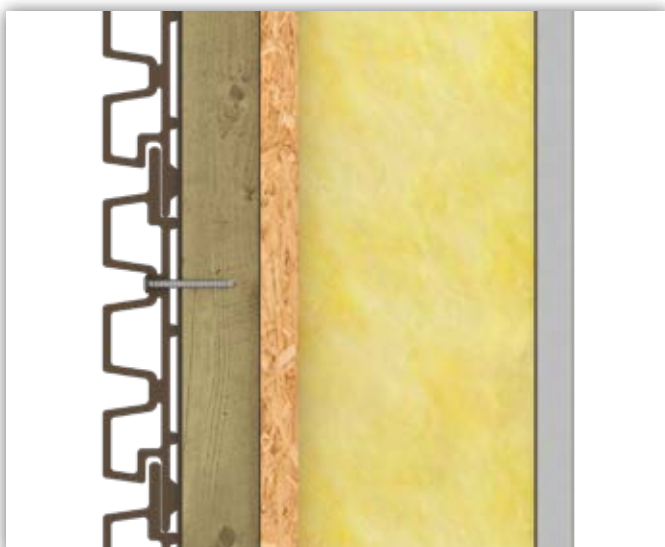
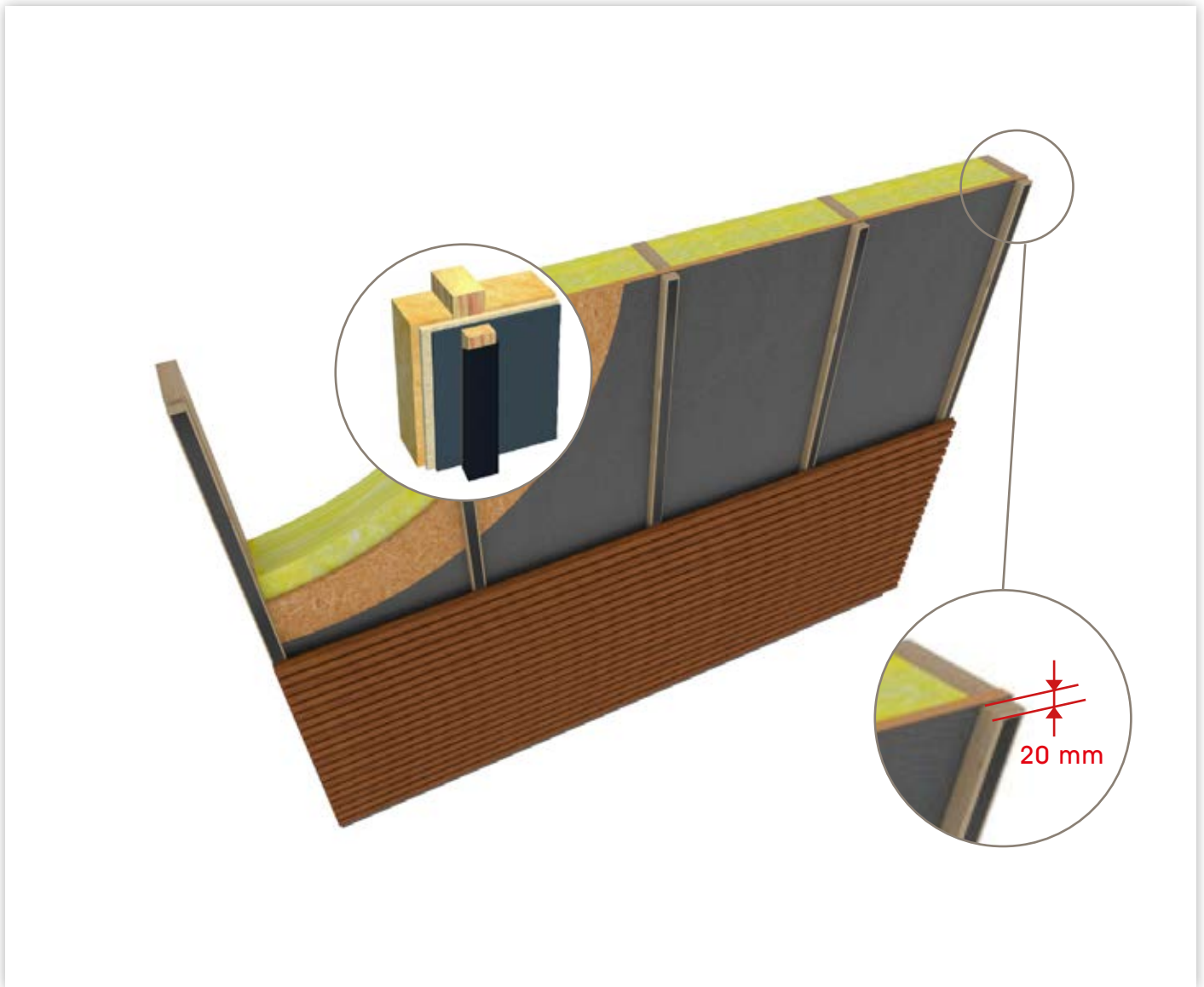

5 - POSE SUR OSSATURE METALLIQUE WEO® 35

5.1 - POSE HORIZONTALE

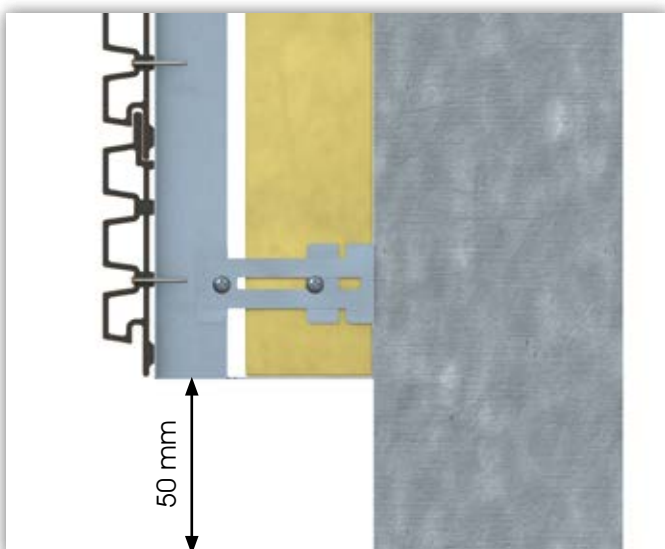
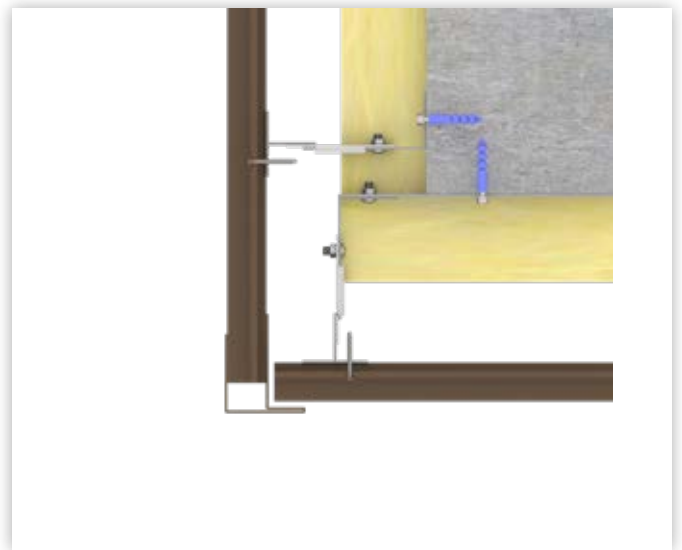
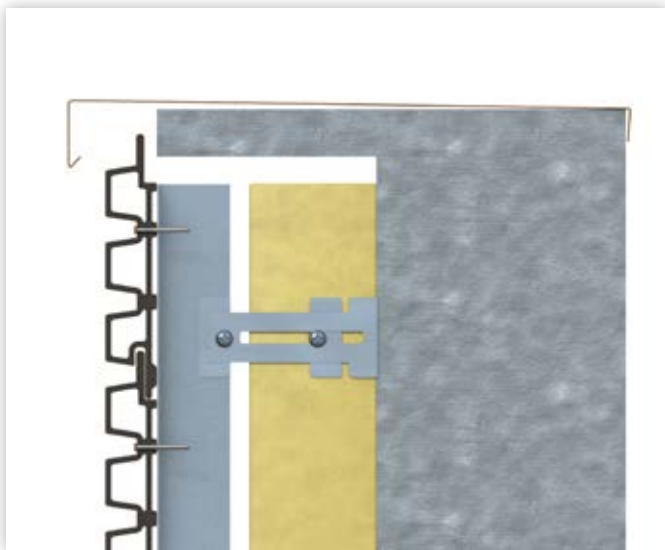
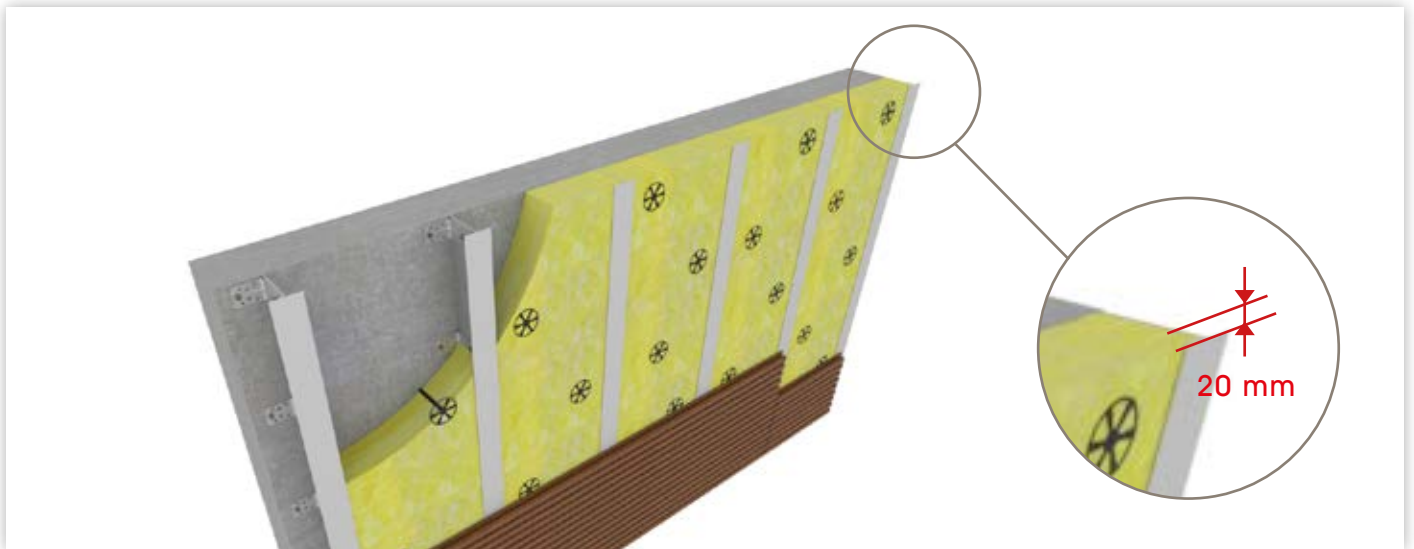

5 - POSE SUR OSSATURE METALLIQUE WEO® 35

5.2 - POSE VERTICALE

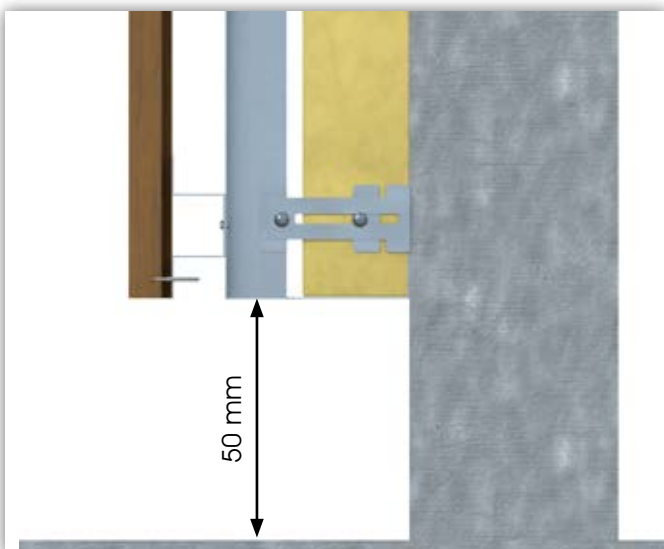
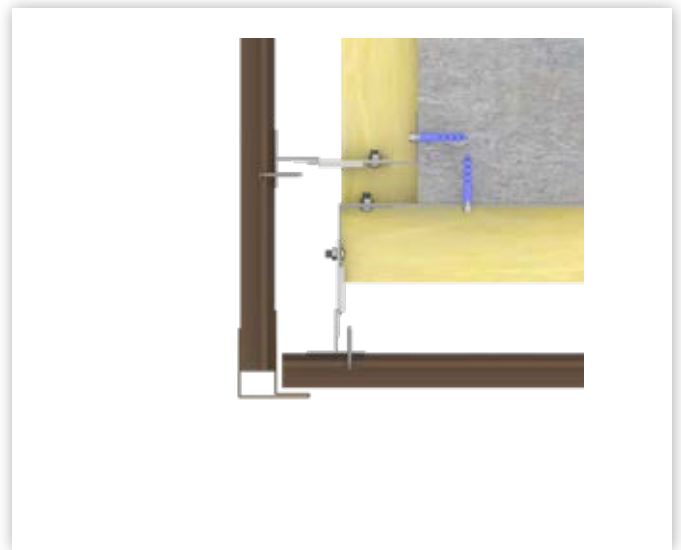
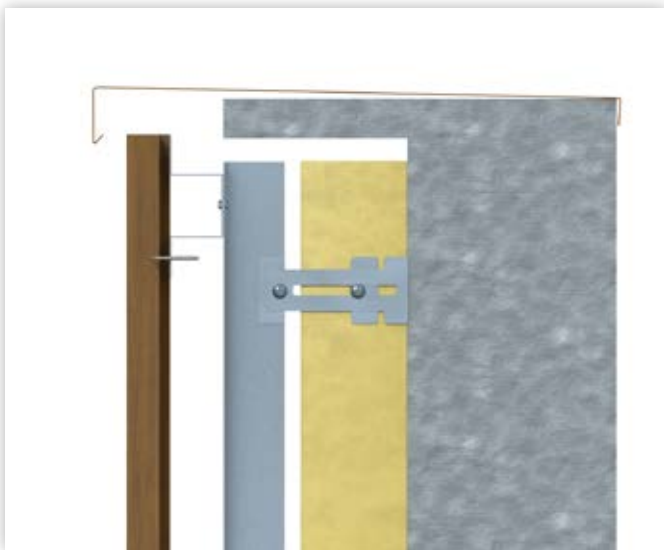
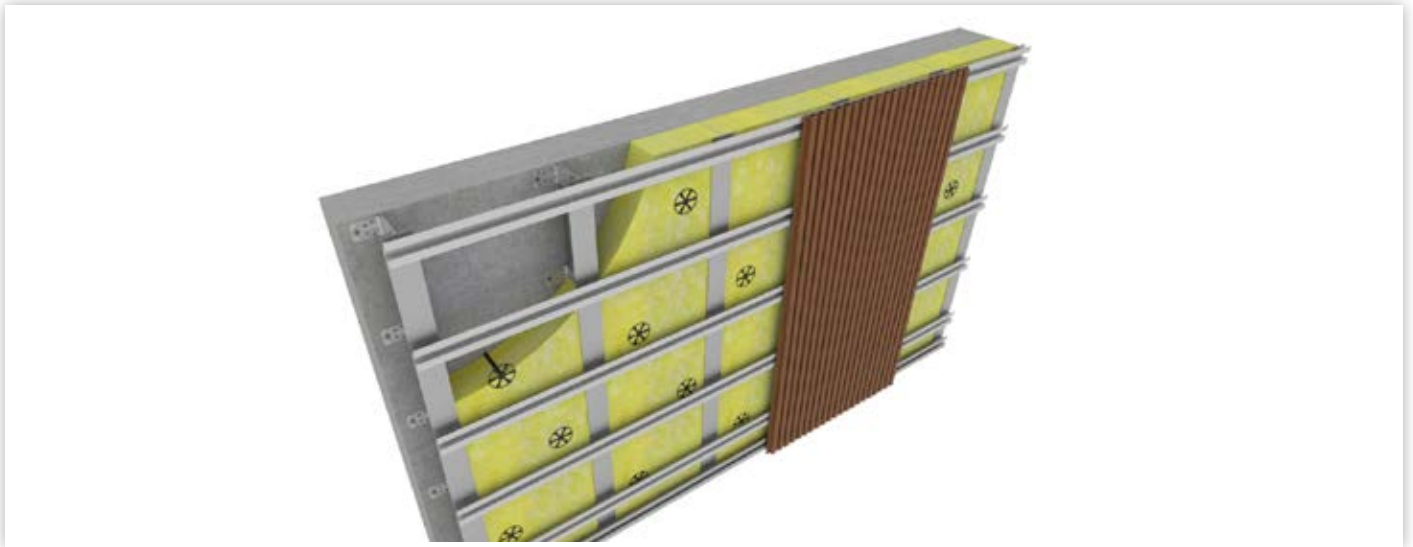

6 - POSE BARDAGE WE0® 60

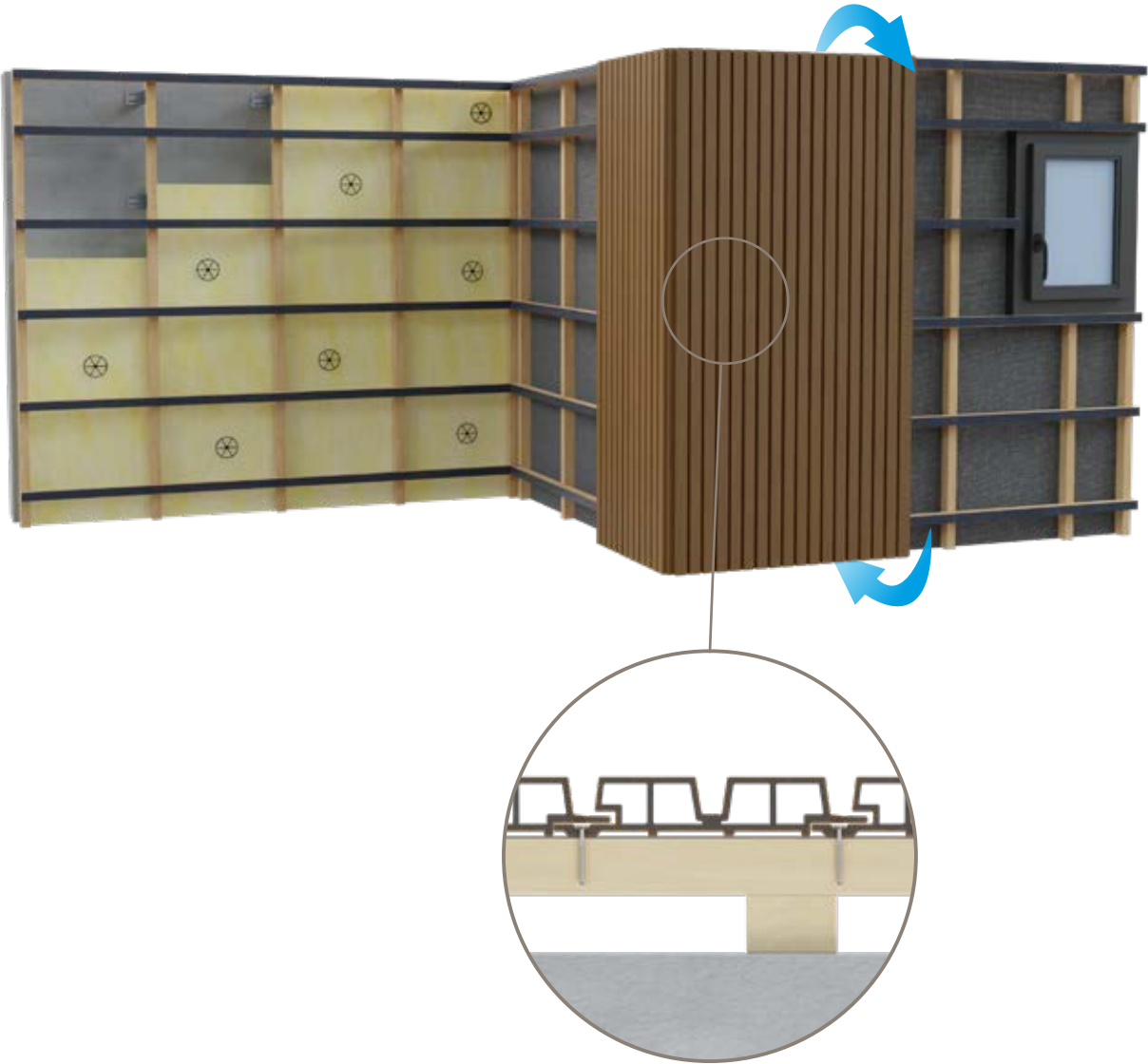

6 - POSE BARDAGE WE0® 60

6.1 - PIED DE MUR ET ACROTÈRE POSE VERTICALE

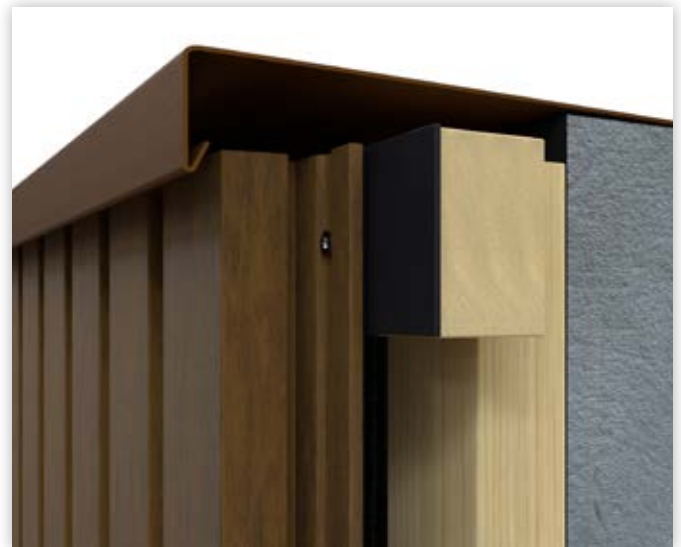
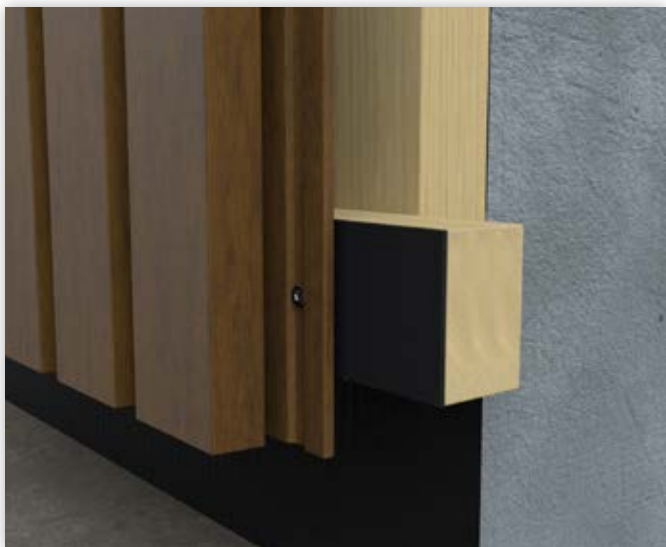
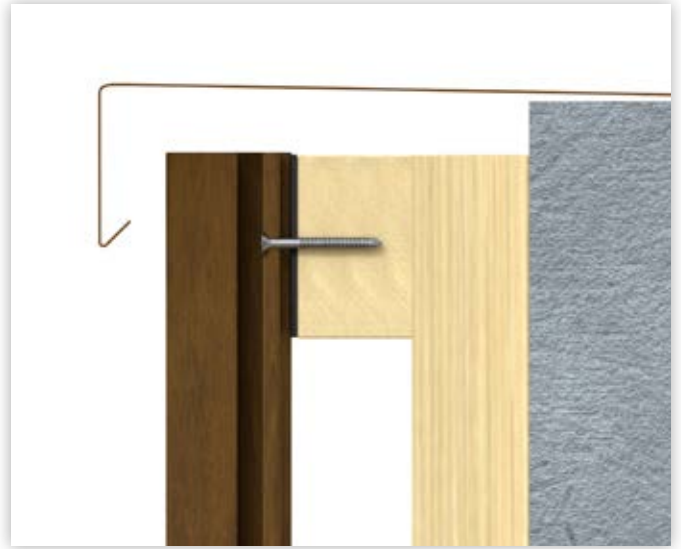

6.1.1 - PIED DE MUR ET ACROTÈRE POSE HORIZONTALE

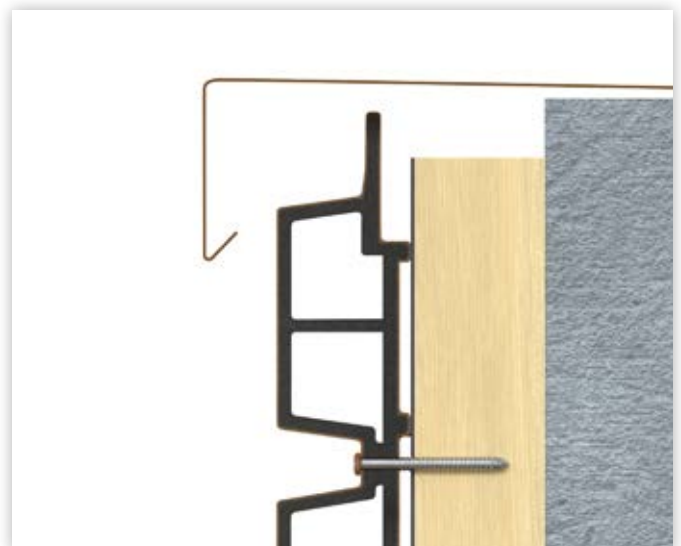
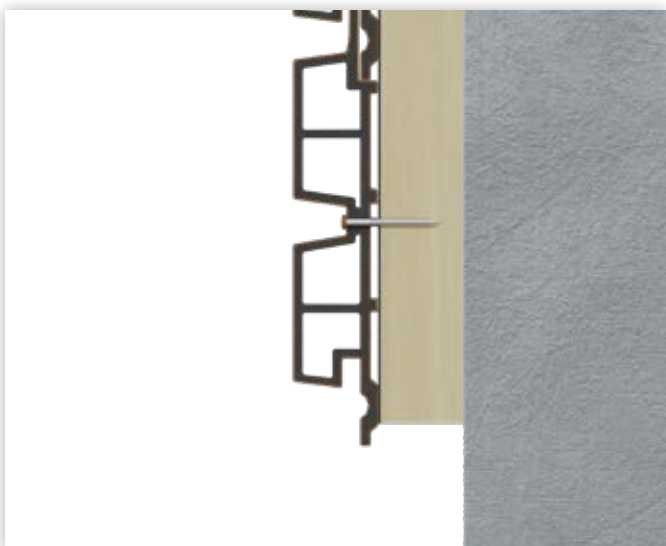

6 - POSE BARDAGE WE0® 60

6.2 - ANGLE SORTANT / RENTRANT

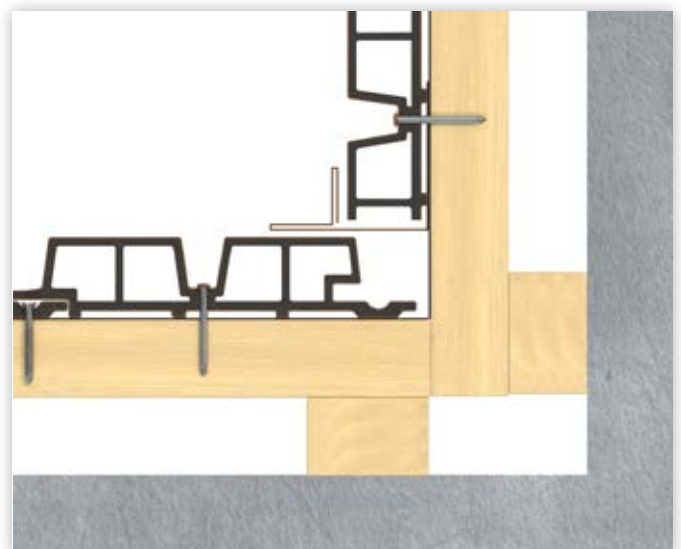
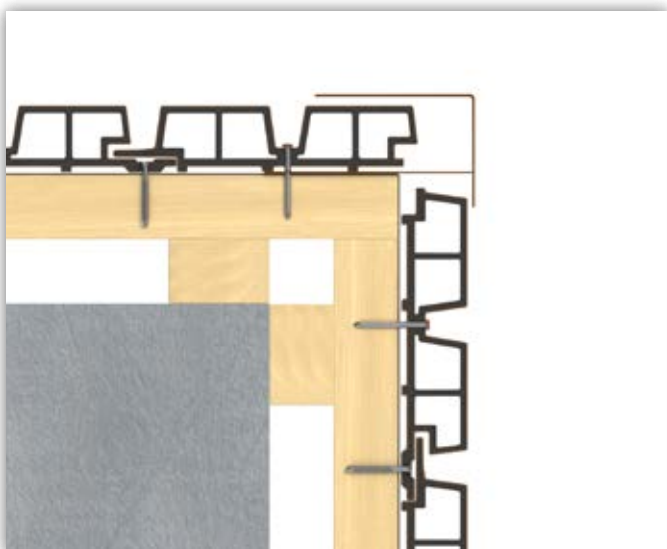
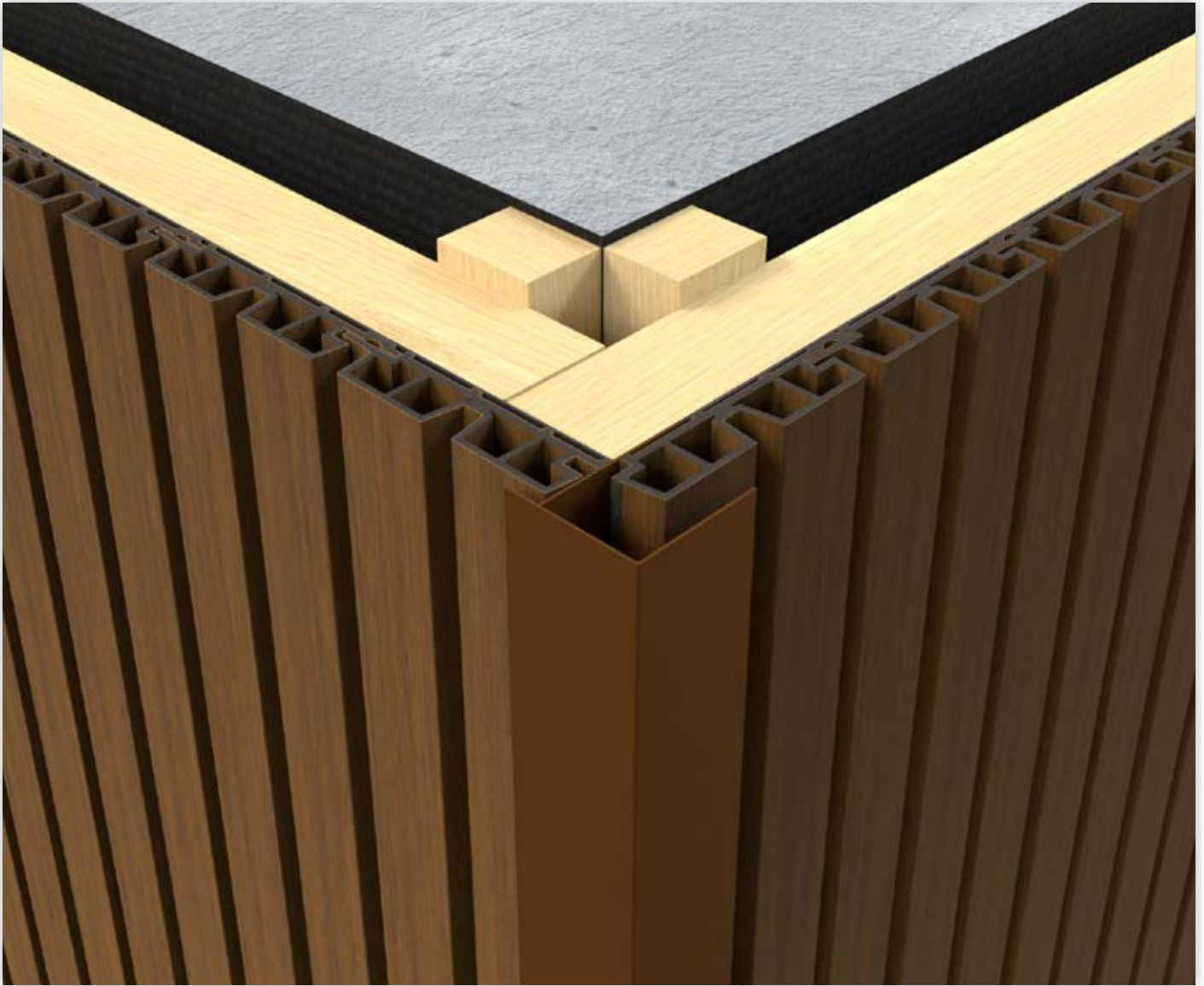

6 - POSE BARDAGE WE0® 60

6.3 - REMPLACEMENT DE LAME

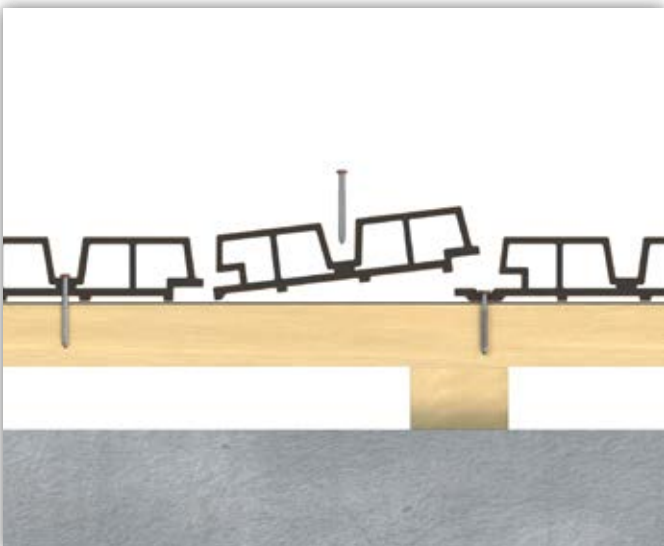
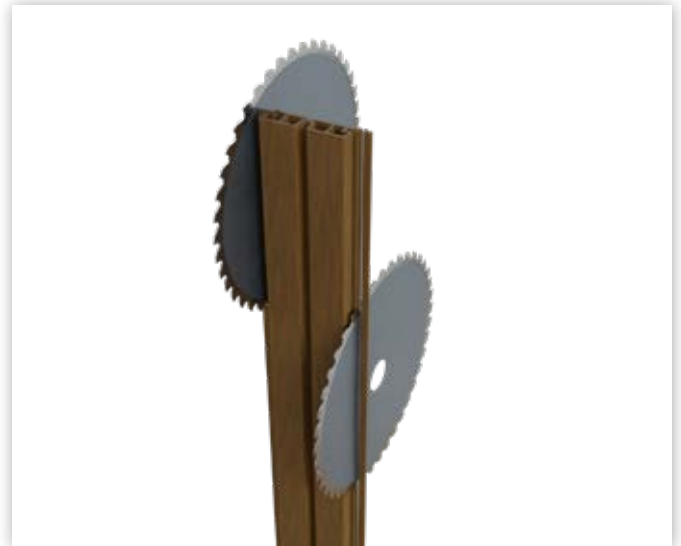
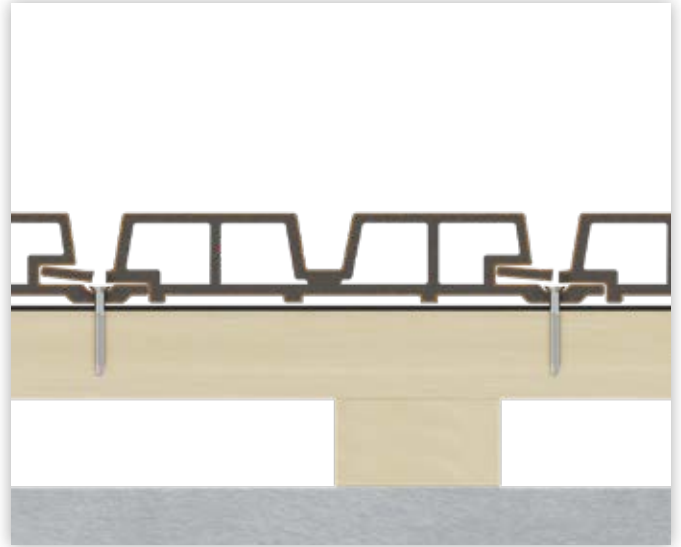
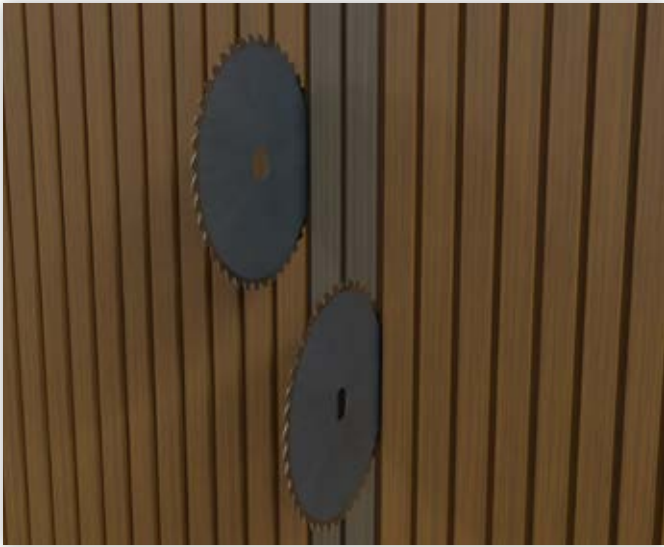

6 - POSE BARDAGE WE0® 60

6.4 - POSE SUR CONSTRUCTION OSSATURE BOIS

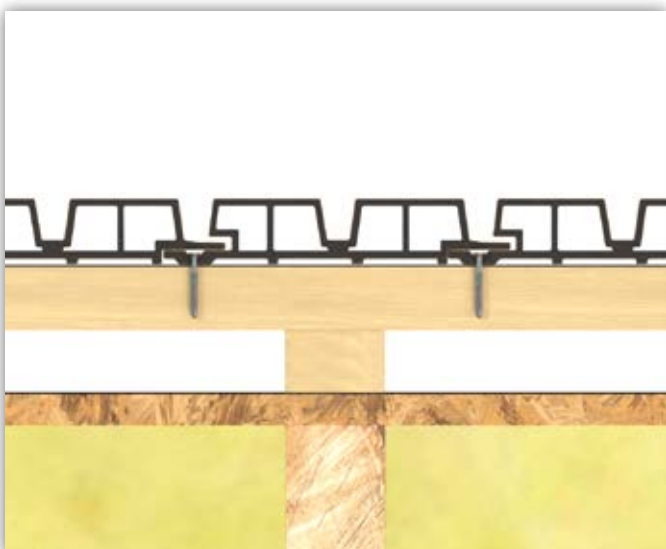
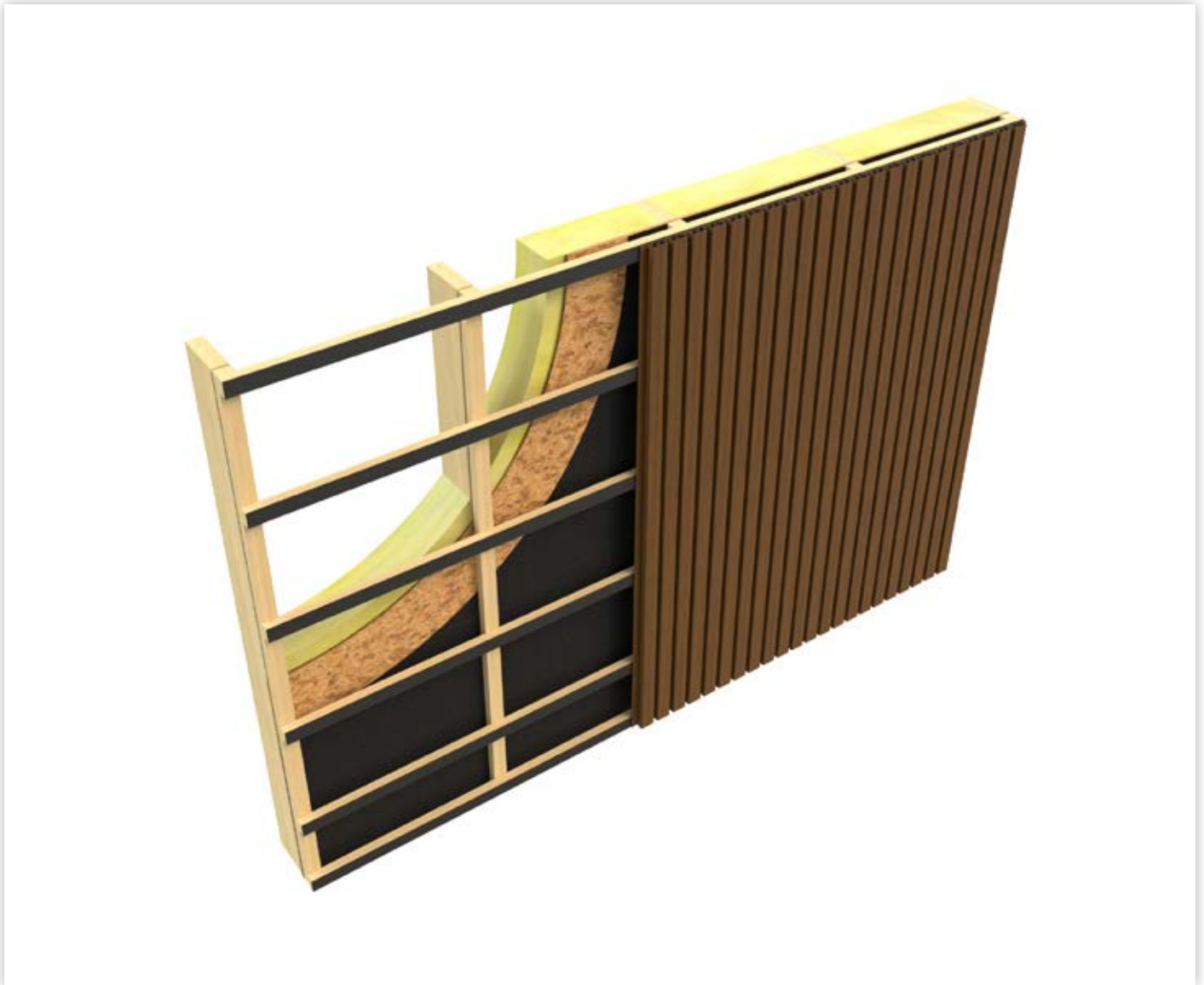

6 - POSE BARDAGE WE0® 60

Compatible mix Weo® 35 / Weo® 60

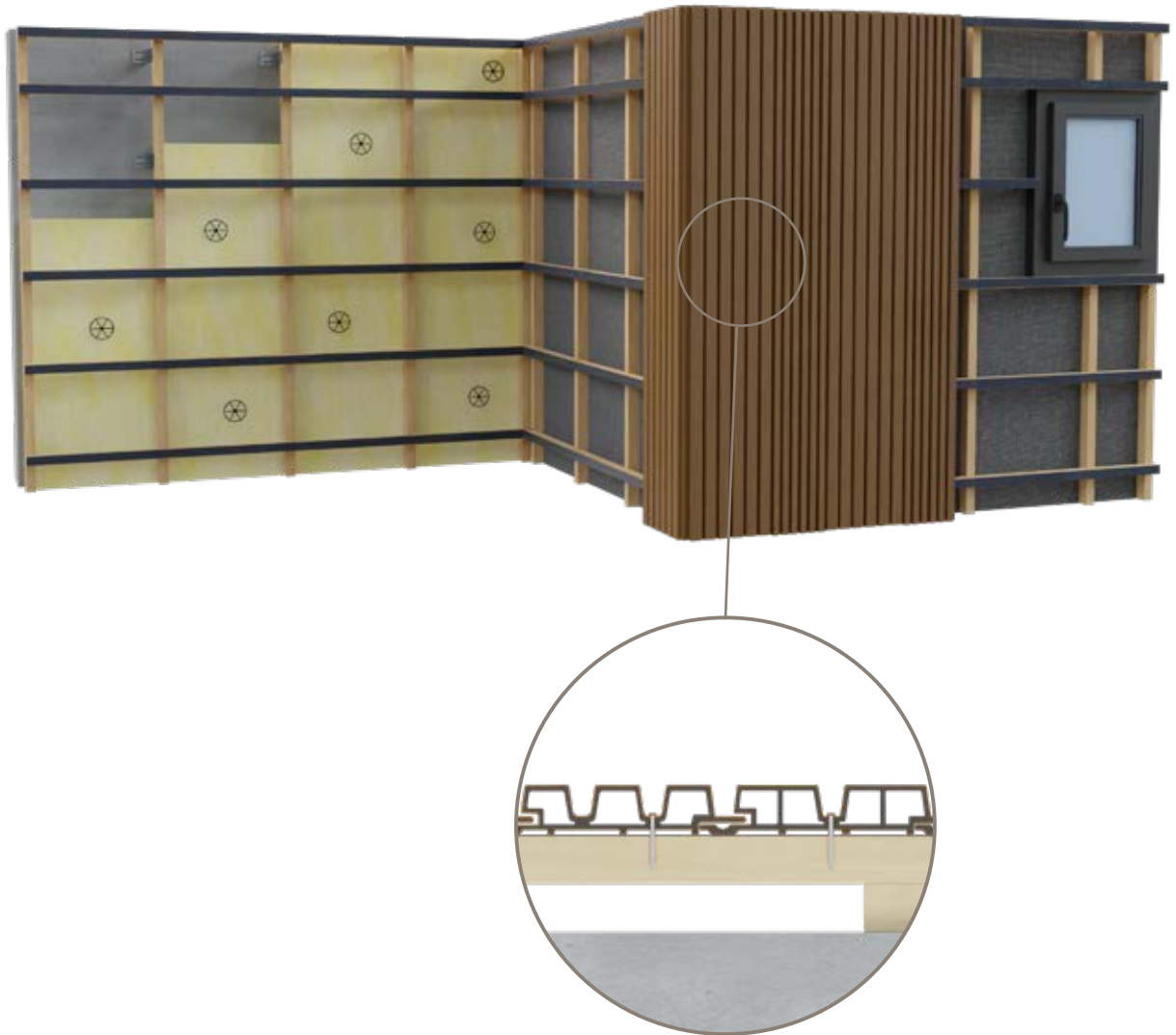



A series of horizontal lines for writing, consisting of 18 lines spaced evenly down the page.

Fiberdeck[®]

fiberdeck.fr